

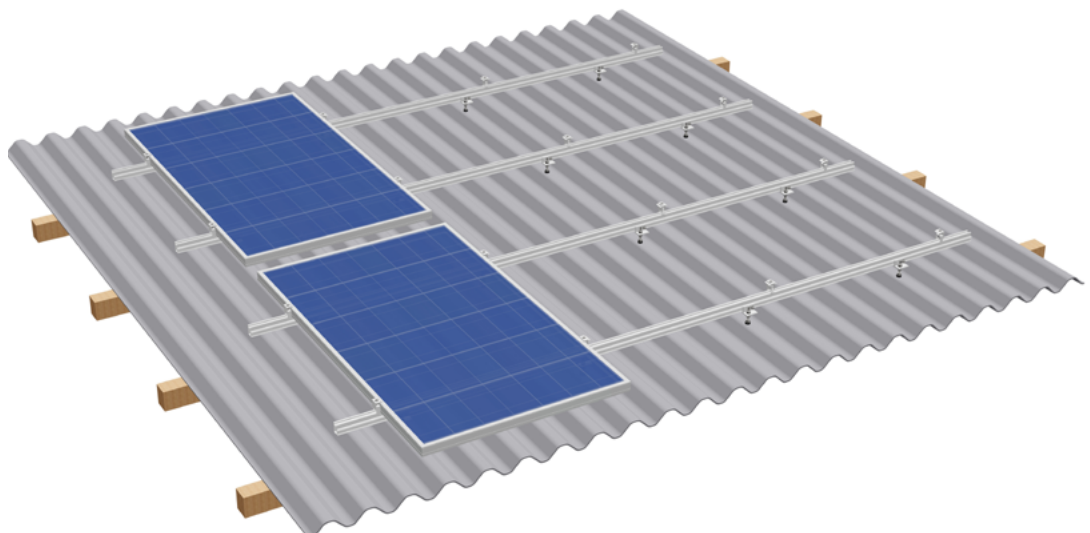

## Assembly Instructions

### HANGER BOLT/SOLAR FASTENER

For trapezoidal sheet metal, corrugated fibre cement, sandwich elements

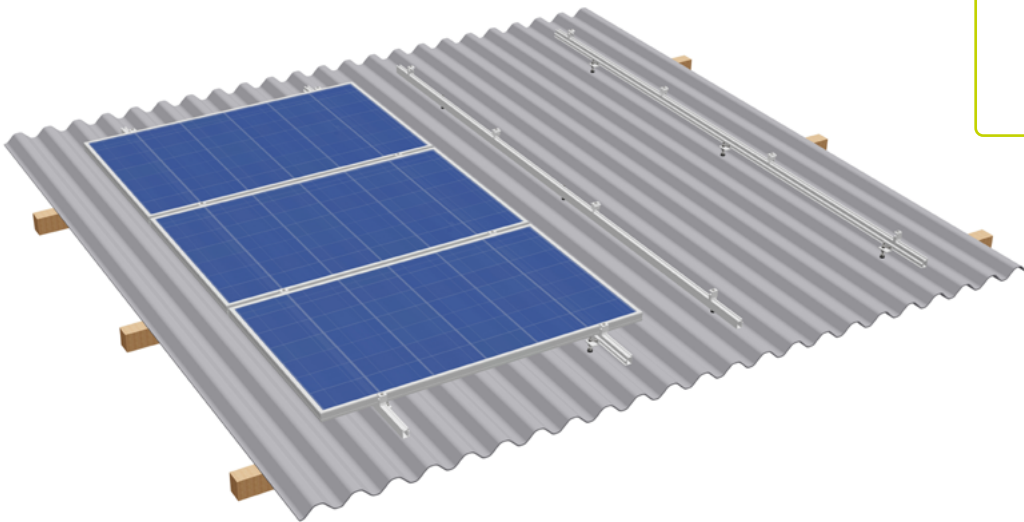
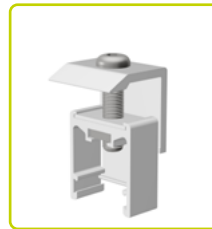
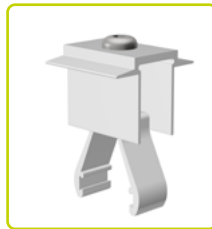

## 1 Introduction

1.1	Intended use	3
1.2	About this document	3
1.3	Warnings	4
1.4	General information — standards and guidelines	4
1.5	Description of the system	6

## 2 Hanger bolt/solar fastener installation

2.1	System components	10
2.2	Installation with hanger bolts/solar fasteners	11
2.2.1	Installing the hanger bolts	12
2.2.2	Mounting the brackets	14
2.2.3	Hanger bolt assembly with multi-solar plate	15
2.2.4	Hanger bolt assembly with adapter rail	15
2.3	Frame assembly	18
2.3.1	Mounting a vertical rail layer for transverse installation	18
2.3.2	Mounting a horizontal rail layer for upright installation	19
2.3.3	Installing the splice	20
2.3.4	Mounting a cross connection	22
2.4	Module installation	24
2.4.1	Module installation, transverse	25
2.4.2	Module installation, upright	29

## 3 Disassembly and disposal

3.1	Disassembly	34
3.2	Disposal	34

## 4 Terms of use and warranty

4.1	User agreement	35
4.2	Warranty / disclaimer	35

Read these installation guidelines carefully before installing the S:FLEX mounting system and retain them for future reference!

These installation guidelines are only complete with the project-specific implementation plans (project report)!

The S:FLEX PV fastening system is a frame system for mounting PV modules on industrial roofs consisting of trapezoidal and corrugated sheet metal, corrugated fibre cement and sandwich elements. It consists of hangar bolts/solar fasteners, brackets mounting rails and all necessary small parts for fastening the PV modules, interconnecting the components and fastening them to the roof substructure (RS).

Both upright and transverse installation of the modules is possible using the S:FLEX PV fastening system. This includes the option of single-layer, as well as double-layer installation.

An outstanding feature of the S:FLEX PV fastening system for industrial roofs is the high availability of pre-assembled parts. The system's patented and proven click technology ensures the shortest possible installation times.

All components are generally made of aluminium and stainless steel. The high degree of corrosion resistance ensures a long service life and offers the possibility of complete recycling.

### 1.1 Intended use

These installation guidelines are intended for a group of people with relevant qualifications who have been instructed by the operator of the PV system. Installation of the S:FLEX PV fastening system on trapezoidal and corrugated roofs and on roofs with corrugated fibre cement sheets and sandwich elements requires extensive expertise on the part of the installer. We therefore recommend contacting a specialist roofing contractor for this purpose.

Corrugated fibre cement sheets and light panels are not penetration-proof! When installing PV systems on roofs with corrugated fibre cement sheets, the admissibility of the installation and if necessary the observance of additional regulations in regard to occupational health and safety must be ensured in advance.

The S:FLEX PV fastening system for industrial roofs is a frame system for mounting PV modules. It is designed exclusively for the installation of PV modules.

Any other use in this regard is considered misuse of the product. In particular, compliance with the instructions in these installation guidelines constitutes intended use. S:FLEX GmbH accepts no liability for damage resulting from non-observance of the installation guidelines or from misuse or incorrect use of the product.

### 1.2 About this document

The S:FLEX PV fastening system for industrial roofs enables installation of elevated PV systems parallel to the roof surface on industrial roofing materials.

For this purpose, the S:FLEX PV fastening system offers suitable components for easy connection to the following roofing materials and structures:

- *Trapezoidal and corrugated sheets*
- *Corrugated fibre cement sheets*
- *Sandwich elements*

### 1.3 Warnings

The warning texts provided in these installation guidelines relay safety-related information. They are:



**Unless observed, there is a major risk of injury as well as a risk of death.**



**Non-compliance may lead to property damage.**

### 1.4 General information – standards and guidelines

Every photovoltaic system must be installed in accordance with the instructions contained in the respective installation guidelines and the project report.

These installation guidelines are based on the currently recognised state of the art and many years of experience installing our systems. It must be ensured that only the current and complete installation guidelines are used for the installation and that a print-out of the installation guidelines is stored in the immediate vicinity of the system. The system and these guidelines are subject to technical changes.

The project report is part of the installation instructions and is created on a project-specific basis. All of the information contained in the project report must be strictly observed. The project report contains the location-based static calculations. The S:FLEX mounting system must be designed and planned using the S:FLEX planning tool.

Since individual project-specific features must be considered with every roof, expert advice must always be sought prior to installation. Before installation, the PV system creator must ensure that the existing roofing and roof substructure are suitable for the additional loads. The condition of the roof substructure, the quality of the roof covering and the maximum load-bearing capacity of the roof construction must be checked by the system creator.

Contact a local structural engineer for this purpose.

When installing the PV system, always comply with the module manufacturer's installation instructions. In particular, it is necessary to check that the module manufacturer's instructions regarding the module clamping guidelines (module clamping surface and clamping range) are complied with. If this is not the case, the customer must obtain a declaration of consent from the module manufacturer before the installation; alternatively, the mounting system must be adapted in accordance with the module manufacturer's specifications.

The requirements for the protection of PV mounting systems against lightning and surges must be met in accordance with the DIN and VDE regulations. The specifications of the relevant power supply company must be observed.

Care must be taken that the PV system to be installed does not impair the functioning of the existing lightning protection system.

Option 1: It is important to ensure that the PV system is designed so that it can be included in the protection zone of the building's lightning protection system.

Option 2: No connection to the lightning protection system: the separation distances between the PV system and the lightning protection system specified in the relevant regulations must be adhered to. To ensure this, contact a company that specialises in lightning protection.

The valid fire protection regulations must be observed during installation. Fire protection walls may not be built over, fire protection compartments must be preserved and the corresponding spacing regulations must be adhered to.

If the roofing is altered, the manufacturer's guidelines must be observed. During and after installation, the frame components may not be stepped on or be used as a climbing aid. There is a risk of falling and the roofing underneath could be damaged.

Prior to installation, the creator of the photovoltaic system must ensure that the installation is carried out while strictly adhering to national and location-specific building regulations, safety and accident prevention regulations, standards and environmental protection regulations.

Every person who installs the S:FLEX PV mounting systems is obligated to independently inform himself/herself about all rules and regulations for professionally correct planning and installation, and to comply with said rules and regulations during the installation process. This also includes compliance with the latest versions of the respective rules and regulations.

Installation of the PV system may only be carried out by trained specialists.



**All system components must be checked for damage before installation. Damaged components must not be used!**



**Installation of the S:FLEX substructure and the PV system may only be carried out by trained specialists. System components must not be used as step ladders. The modules must not be stepped on. When working on roofs, there is a risk of falling off and falling through roofs. A fall can result in injury or death. Ensure that appropriate climbing aids and fall-protection equipment (e.g. scaffolding) are provided as well as protection from falling parts.**



**When working on corrugated fibre cement roofs, there is a risk of falling through the roof. A fall can result in injury or death. Suitable fall-through protection (e.g. safety nets) must be provided.**



**Check the building statics and construction/condition of the roof substructure before starting the installation. During installation, the instructions in the installation guidelines and project report must be strictly observed. Failure to observe the installation guidelines and the project report may result in damage to the PV system and to the building.**

## 1.5 Description of the system

The S:FLEX system with hanger bolts/solar fasteners offers suitable solutions for different requirements:

### System properties: hanger bolts/solar fasteners

Application:	Trapezoidal and corrugated sheet metal, corrugated fibre cement and sandwich elements
Module type:	Framed and frameless modules
Module orientation:	Upright, transverse
Module dimensions:	variable
Roof inclination:	max. 75°
Module field length:	max. 12.00 m connected module array
Max. load:	5.4 kN/m <sup>2</sup>
Connection:	Hanger bolts/solar fasteners
Material:	Aluminium EN AW-6063 T6, stainless steel A2 fasteners and screws
Colour:	Natural aluminium



**The module manufacturer's installation instructions must always be observed. All of the manufacturer's specifications relating to installation on the roofing must be observed.**

## Mounting rails

The S:FLEX pitched roof system is available with aluminium mounting rails of different thickness to ensure the system corresponds

optimally to the requirements of the location and the installation situation.

The S:FLEX mounting rails feature a hammerhead slot on the side for connection to the fasteners. The mid clamps and end clamps are mounted from above by means of click technology.

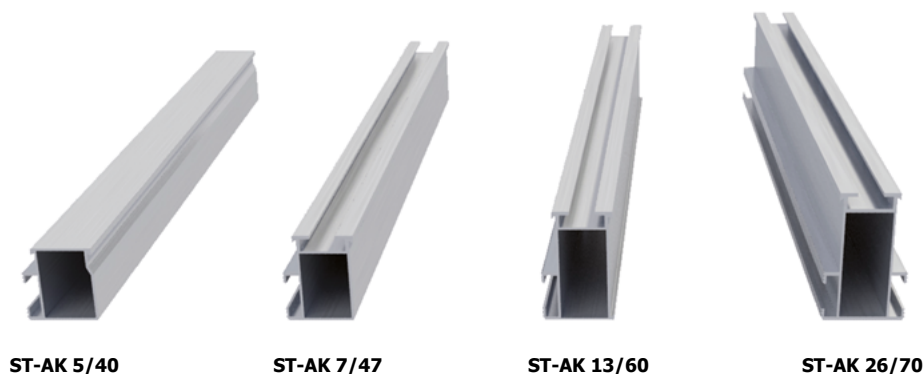

## Rail splices

In addition to the basic installation, the splice technology allows a system orientation without a reduction in the load-bearing capacity in the area of the splices, since they have the same static values as the associated mounting rail.

When connecting the mounting rails in succession using splices, an earthed connection can be created by applying pressure to push the mounting rails together flush to the splices. It must be ensured that the earthed connection is professionally inspected on site after installation.

In addition, the splice technology offers the possibility to quickly and easily create expansion joints according to the conditions of the roof.

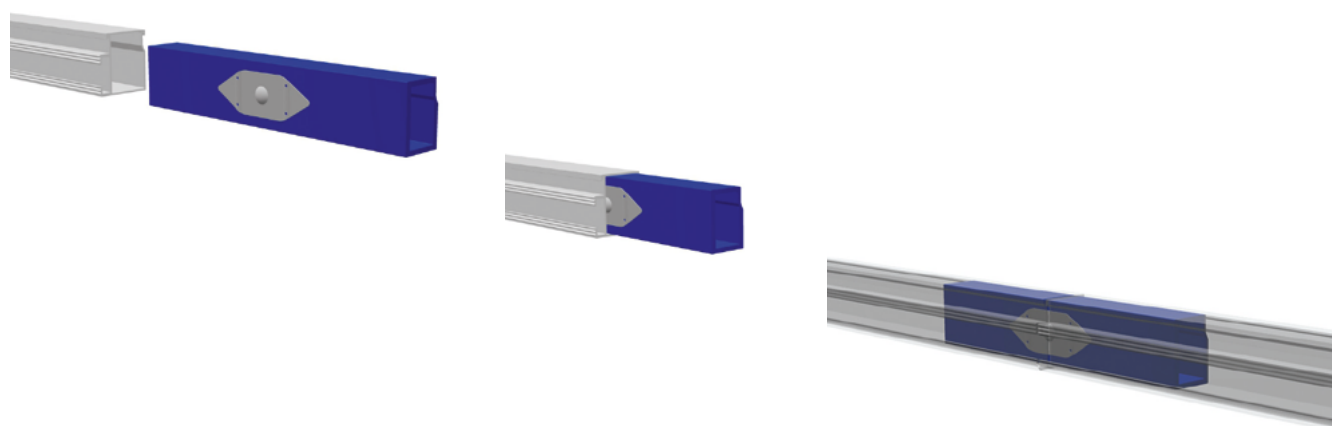

### Cross adapters

Intersection points (for double-layer systems) can be quickly realised in a load-bearing manner with cross adapters with patented and proven click technology. Depending on the static requirements of the location and the installation situation, two or four cross adapters must be arranged per intersection point.

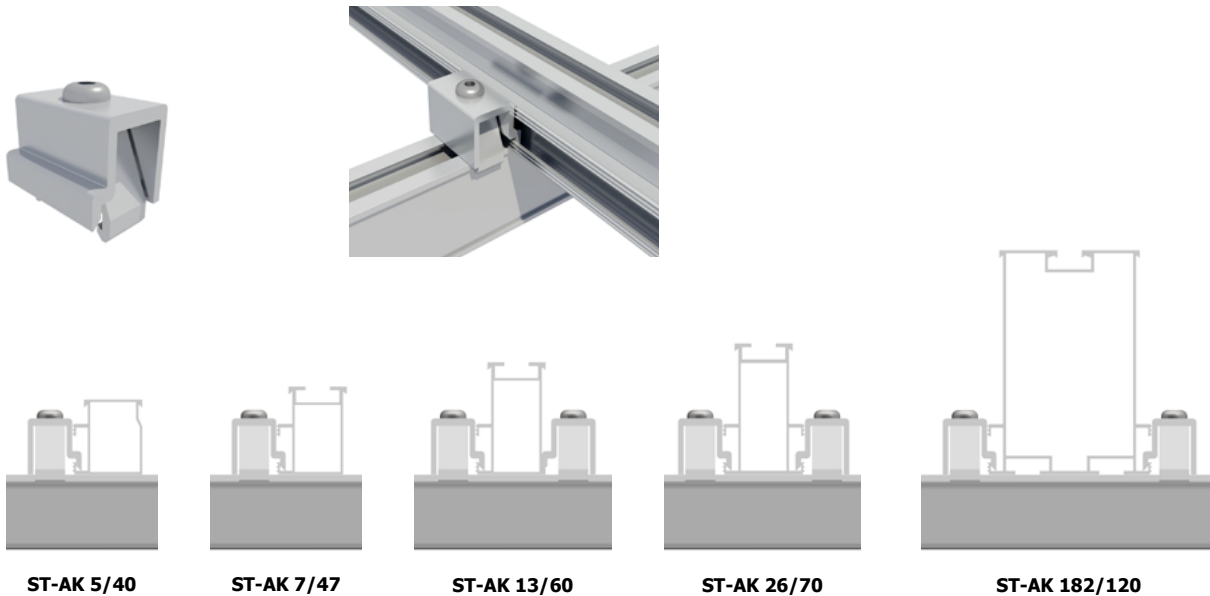

### Module mid clamps and module end clamps

Height-adjustable module mid clamps and module end clamps with click technology allow for maximum flexibility when installing virtually all framed module types with a frame height of 30 – 50 mm. When installing the PV modules to the mounting rail, always comply with the installation instructions of the module manufacturer.

When performing the fastening by means of the module mid clamp and module end clamp, ensure that these clamp onto the module frame on the clamping surface defined by the module manufacturer. Every person who installs the S:FLEX PV fastening systems is obligated to ensure that the existing clamping surfaces correspond with the module manufacturer's installation instructions. If the maximum clamping surfaces of the module mid clamps and module end clamps are insufficient, it is also possible to obtain the components in different lengths.

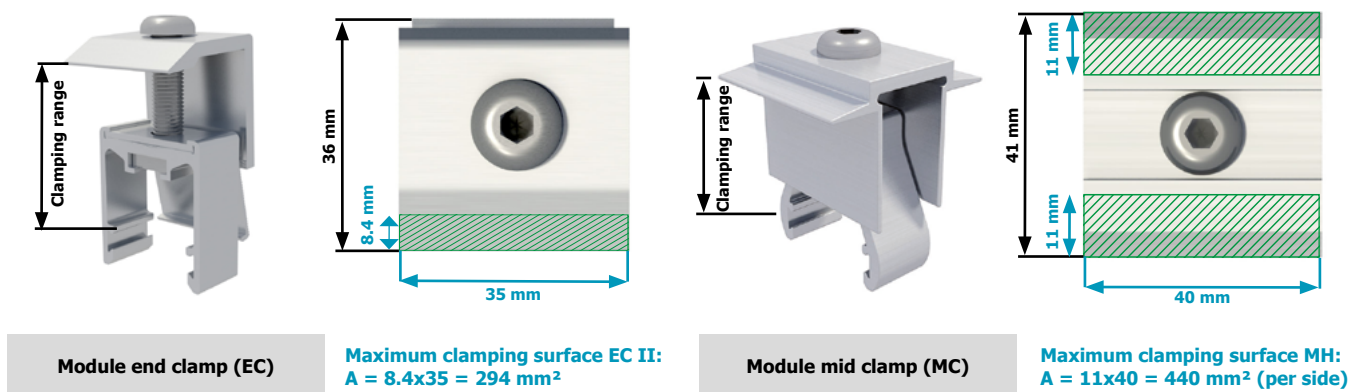



## Earthing

Equipotential bonding between the individual system components must be ensured in accordance with the respective country-specific guidelines and standards. System-specific properties (see splice technology) among other things can be used for this purpose.

This installation recommendation does not include an earthing concept and must be calculated or compiled by the installer in accordance with the applicable standards and guidelines.



**The earthing system is not a lightning protection system! When installing a lightning protection system, a specialist company must be consulted and a project-specific lightning protection plan drawn up. The module manufacturer's installation instructions must always be observed.**

The earthed connection of the mounting rails is established by the splice. Additional earthing of the modules can be achieved via the grounding plate by mounting it under the mid clamps. Before earthing the module, the corresponding specifications issued by the module manufacturer must be followed.

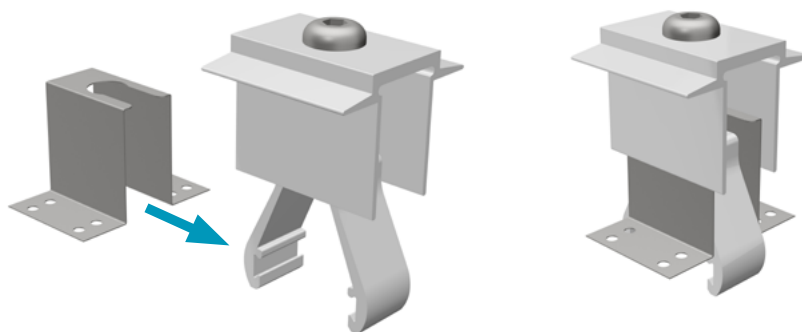

The earthing terminals enable the mounting system to be integrated into the equipotential bonding system by means of aluminium round wire. Clamping range for round wire: 8–10mm; connection area: 4–50 mm<sup>2</sup> (solid and stranded wires are possible).

The connection to the hammerhead channel is made with a hammerhead bolt and locking nut. If mounting directly on the aluminium profile, use a thin sheet metal screw.

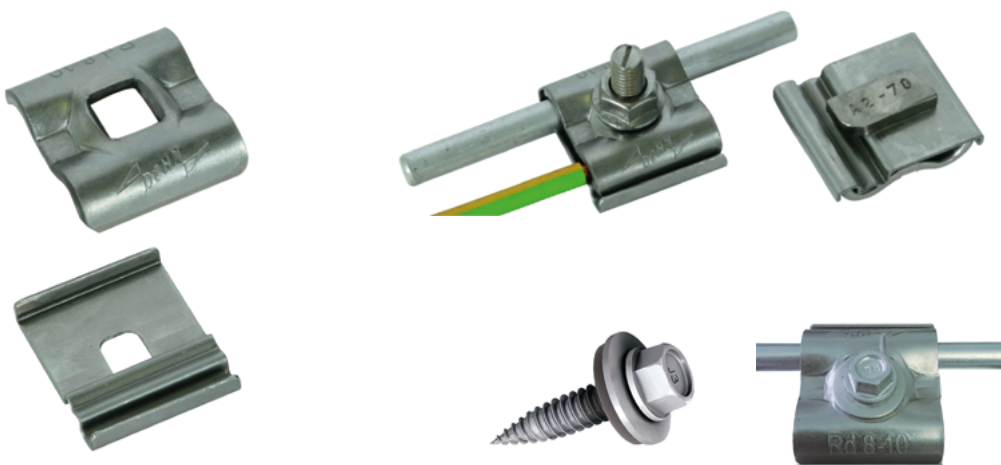

### 2.1 System components

#### ① Roof fastening

Hanger bolt

Solar fastener A

Solar fastener BZ



Bracket 40 mm M8

Bracket 60 mm M10

Bracket 60 mm M12



Adapter rail  
l=235/366



#### ② Mounting rails

ST-AK 5/40

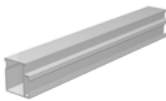

ST-AK 7/47



ST-AK 13/60



ST-AK 26/70



#### ③ Splices

Splice 5



Splice 7

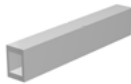

Splice 13



Splice 26



#### ④ End clamp

EH AK II Klick 30-50



EH AK II Klick 30-50  
black



#### ⑤ Mid clamps

MH AK II Klick 30-50 A



MH AK II Klick 30-50  
black



#### ⑥ Cross adapter

Cross adapter AK



MH AK II Klick 30-50 with  
grounding plate



#### ⑦ Covering caps

Covering cap 5



Covering cap 7



Covering cap 13



Covering cap 26



#### ⑧ Slipping protection set

Slipping protection set



#### ⑨ Locking clips

Locking clip AK



#### ⑩ Multi-solar plate

Multi-solar plate



#### ⑪ Grounding clamp

Grounding clamp  
DEH uni HK



#### ⑫ Cable clips (optional)

Cable tie  
Cable clip KC 15



#### ⑬ Project mounting rails

ST-AK 182/120



### Installation instructions for hanger bolts/solar fasteners

#### 2.2 Installation with hanger bolts/solar fasteners

Hanger bolts/solar fasteners enable installation directly on the purlins or rafters. This creates a load-bearing connection between the building substructure and the PV mounting system. This mounting variant is particularly advantageous in regions with high wind loads.

Hanger bolts/solar fasteners can be used for direct connection to the roof substructure for the following roof coverings:

- *Trapezoidal and corrugated sheets*
- *Corrugated fibre cement sheets*
- *Sandwich elements*
- *Flat roof coverings with bitumen or shingles*

Hanger bolts are used for wooden roof substructures. Solar fasteners can be used for roof substructures made of metal or wood. These connections are possible for pitched roofs with a max. roof inclination of 75°.

The positioning of the hanger bolts/solar fasteners must be determined in accordance with the location-specific static requirements and the installation situation. When doing so, it must again be checked whether the measurements used during planning match the actual measurements found on the roof (if necessary, adjustments must be made).

At the marked positions, the holes must be drilled through the roofing in the area of the raised corrugations/crests. If there are screws that serve to fasten the roof covering at the marked points, these must be removed. Instead, the hanger bolts/solar fasteners are used to fasten the roof covering. The existing holes may need to be drilled out. When drilling through the roof covering, the following drilling widths must be observed:

- Hanger bolts: diameter + 4 mm (e.g. hanger bolt M10: 14 mm)
- Solar fasteners type A and type BZ: 9 mm

Insert the hanger bolts through the pre-drilled holes in the roof covering and screw them perpendicular to the roof surface into the purlins or rafters below.

A form fit connection must be ensured between the gaskets or calottes and the roof cladding.

If using EPDM gaskets/shield gaskets, make sure that they are not compressed too much. The gasket must not be pressed beyond the end nut.

For flat roof coverings with artificial slate, bitumen shingles and sheet metal shingles, Multi-solar plates can be used for roof sealing.

It must be ensured that the hanger bolts are capable of safely transferring the occurring forces into the roof structure and guaranteeing the tightness of the roof covering. The load-bearing capacity of the hanger bolts must be verified.

## Installation instructions for hanger bolts/solar fasteners

### 2.2.1 Installing the hanger bolts

#### Wood substructure – specifications for the mounting of hanger bolts and type A solar fasteners

- Standard: DIN EN 1995-1-1:2010-12 Eurocode 5 Dimensioning and design of timber structures
- Wood substructures must be pre-drilled for the installation of wood screws with screw diameter  $d > 6\text{mm}$  ( $d$  = screw diameter)
- Purlins and rafters made of wood ( $d \geq 8\text{mm}$ ) must ALWAYS be pre-drilled before installation of hanger bolts and type A solar fasteners.
- Pilot hole diameter:  $0.7xd$
- Screw-in depth: at least  $4xd$
- Purlin installation, edge distance at bottom and top: at least  $4xd$  each
- **Purlin installation, minimum timber width:  $8xd$**  e.g. for hanger bolt 10x200: Minimum timber width 80 mm
- Rafter installation, lateral edge distance: at least  $3xd$
- Hole spacing in fibre direction: at least  $7xd$
- **Rafter installation, minimum timber width:  $6xd$**  e.g. for hanger bolt 10x200: Minimum timber width 60 mm



**Wood is an organic building material. The quality of wood can deteriorate due to weathering and ageing. Check the quality of the purlins (or rafters) before installation and seek advice from a professional.**

#### Metal substructure – regulations for mounting with type BZ solar fasteners

- Standard: DIN EN 1993-1-1 Eurocode 3 Dimensioning and design of steel structures
- Mounting with type BZ solar fasteners ( $d=8.0\text{ mm}$ )
- Minimum material thickness: 1.5 mm steel (e.g. Z purlins)
- The steel substructure must be pre-drilled before installing type BZ solar fasteners
- Steel substructure 1.5–5.0 mm: pilot hole width 6.8 mm
- Steel substructure 5.0–8.0 mm: Pilot hole width 7.0 mm
- Steel substructure 8.0–10.0 mm: pilot hole width 7.2 mm
- Steel substructure  $> 10.0\text{ mm}$ : pilot hole width 7.4 mm
- Screw-in depth: 20-25 mm
- Purlin installation, edge distance at bottom and top: at least 24 mm ( $3xd$  each) / minimum metal width: 48 mm
- Rafter installation, lateral edge distance: at least 24 mm ( $3xd$  each) / minimum metal width: 48 mm
- Hole spacing: at least 40 mm



**The selection of the appropriate hanger bolts/solar fasteners depends on the material and structure of the roof substructure, the thickness of the roof covering (core thickness and crest height), the roof pitch and the expected loads. Refer to the S:FLEX project report for the appropriate screws.**

### Installation instructions for hanger bolts/solar fasteners

#### Wood substructure

**Corrugated sheet metal:** Type A solar fastener or hanger bolt (EPDM shield gasket or matching calotte)

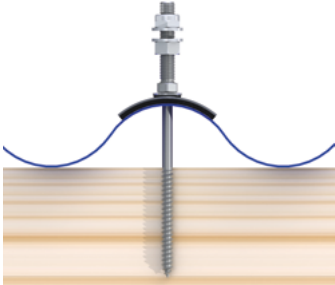

**Corrugated fibre cement:** Type A solar fastener or Hanger bolt (EPDM shield gasket)



#### Steel/metal substructure

**Corrugated sheet metal:** Solar fastener Type BZ (EPDM shield gasket or suitable calotte)

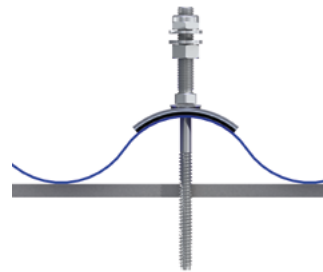

**Corrugated fibre cement:** Solar fastener Type BZ (EPDM shield gasket)



**Trapezoidal sheet metal** (without illustration): Type A solar fastener or hangar bolt (EPDM shield gasket or suitable calotte)

**Trapezoidal sheet metal** (without illustration): Type BZ solar fastener (EPDM shield gasket or suitable calotte)

**Sandwich profiles:** Solar fastener Type A (suitable calotte)

**Sandwich profiles:** Solar fastener Type BZ (suitable calotte)

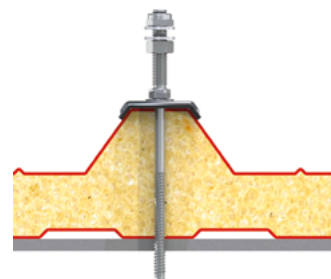
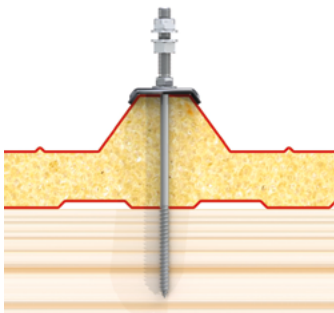

**When selecting the appropriate calotte, the following dimensions must be observed:**

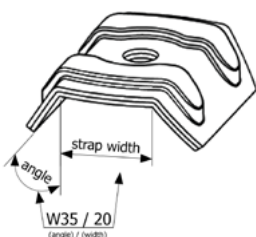

Trapezoidal sheet

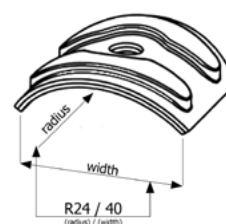

Corrugated sheet metal

### Installation instructions for hanger bolts/solar fasteners



**Check planning basis.**



**Align the hanger bolt using a plumb line.**



**Position them in accordance with the static requirements and the installation situation.**



**Observe edge distances and screw-in depths.**

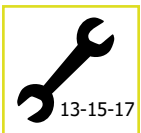

#### 2.2.2 Installing the brackets

Following the installation of the hanger bolts, brackets are attached to the hanger bolts/solar fasteners. The brackets are used to attach them to the mounting rails. Select the bracket depending on the diameter of the upper metric section of the hanger bolt/solar fastener:

- Bracket 40 mm, M8
- Bracket 60 mm, M10
- Bracket 60 mm, M12

The load-bearing capacity of the hanger bolts is designed to allow a maximum distance from the bracket to the roof surface. The maximum distance between the mounted bracket and the roof surface must not exceed 40 mm.

Mounting the brackets: remove the first nut (or nut + lock washer); set the desired mounting height of the angle with the second nut; position the bracket; screw on the first nut (tightening torque M8:

12–15 Nm, tightening torque M10: 20–25 Nm, tightening torque M12: 25–30 Nm). The maximum distance of the bracket to the roof covering must be observed.

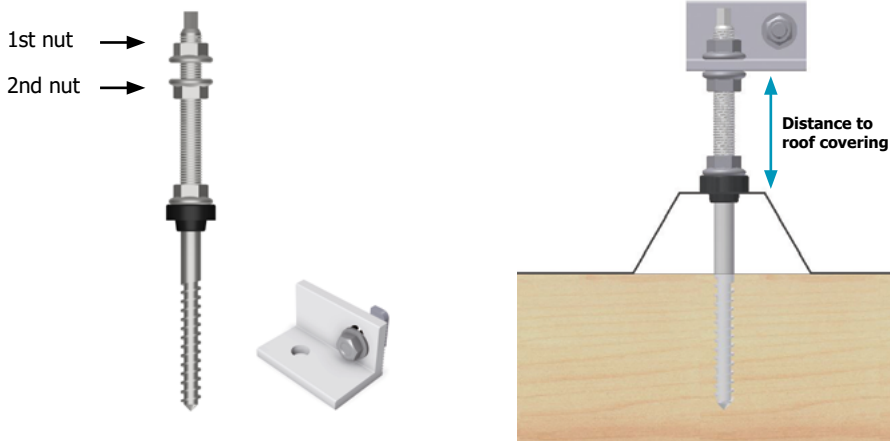

### Installation instructions for hanger bolts/solar fasteners

#### 2.2.3 Hanger bolt assembly with multi-solar plate

The multi-solar plate is inserted between the individual shingle layers above the rafter. Drill through the roof covering through the hole in the solar panel. Drilling width = diameter of the hanger bolt + 5mm. In the next step, pre-drill the rafter/purlin as described in 2.2.1. Now screw in the hanger bolt and make sure that the EPDM gasket lies firmly and flush on the sheet metal.

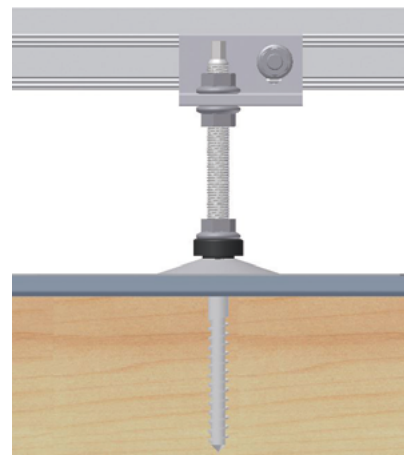
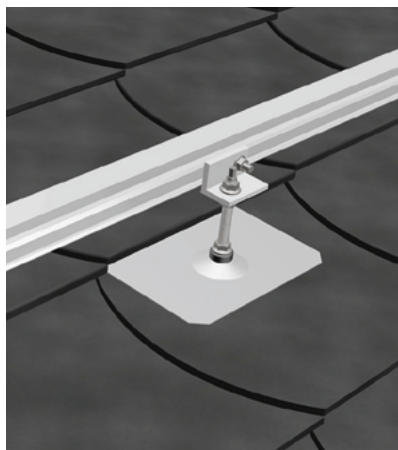
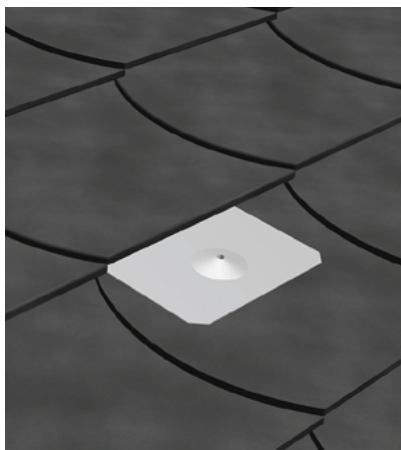

#### 2.2.4 Installing the hanger bolt with adapter rail I=235/366 and lower rail layer

If the forces to be transmitted are too great for a connection with a hanger bolt, adapter rails can be used. With the adapter rail, 2 hanger bolts can be connected to each other. Pre-cut round holes and slots allow precise mounting.

The adapter rail I=366 is pre-drilled for a hanger bolt spacing of 199 mm – 333 mm and is suitable for trapezoidal sheet metal or sandwich roof coverings.

The adapter rail I=235 is specially designed for the corrugation dimensions of corrugated fibre cement roofing (177 mm) and hanger bolt spacings of 68 mm – 202 mm. The rail is also pre-drilled with  $d=12.5$  mm holes.

Two hanger bolts/solar fasteners must be completely screwed into horizontally adjacent raised beads or corrugations on the same purlin. Remove the first (top) nuts, place the adapter rail on both hanger bolts/solar fasteners and on the second nut. The second nut can be used to adjust the height. Maximum distance to the roof covering: 40 mm. Screw the first nuts back on and tighten (tightening torque M10: 20–25 Nm, tightening torque M12: 25–30 Nm).

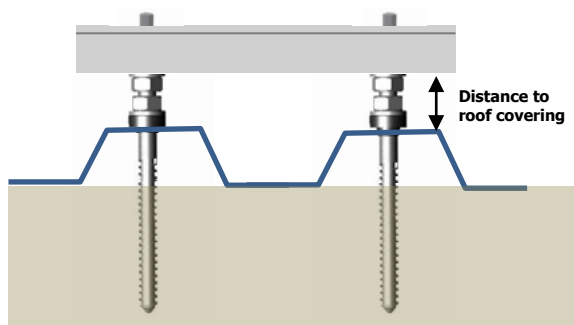
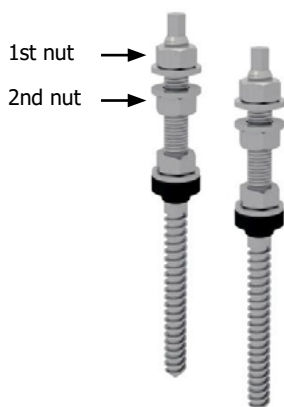

**The maximum distance to the roof covering must be observed**

## 2 Hanger bolt/solar fastener installation

### Installation instructions for hanger bolts/solar fasteners

The adapter rails are installed horizontally. The vertical mounting rails are then positioned and fastened on both sides with cross adapters.

To do this, click the cross adapters onto the adapter rail and fasten the vertical mounting rail in the lateral hammerhead screw channel and opposite. Ensure that the cross adapter is clicked in on both sides of the adapter rail and fasten the screws tightly (torque 8–10 Nm).

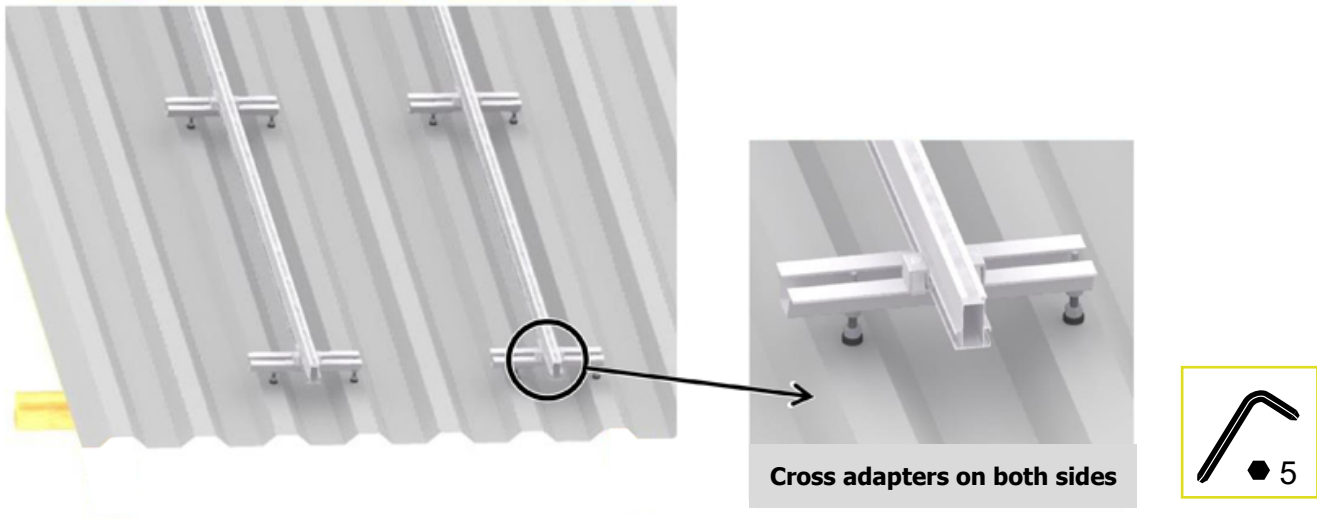

Depending on the static requirements of the location and the installation situation, several cross adapters (2x2) may be required per intersection point.

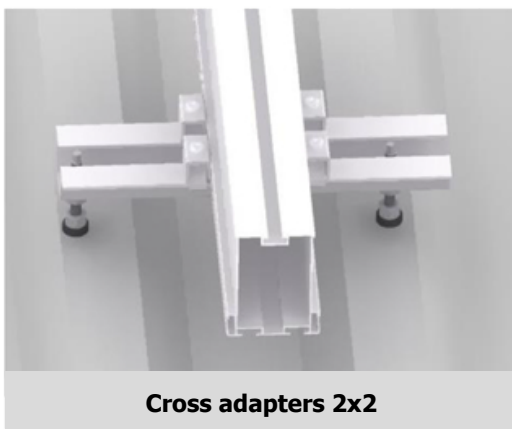



### Installation instructions for hanger bolts/solar fasteners

The number of cross adapters required per fixing point can be found in the project report. A second cross adapter is mounted as described above. Position it on the side of the rail opposite the first cross adapter (tightening torque 8–10 Nm).

#### Intersection points:

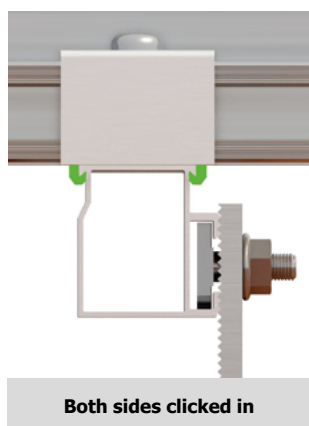
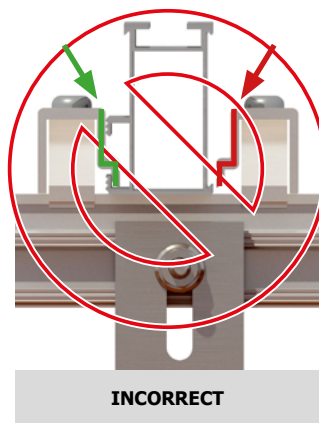
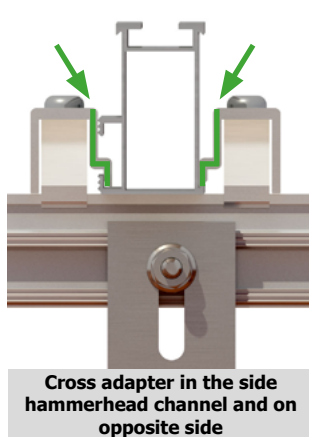
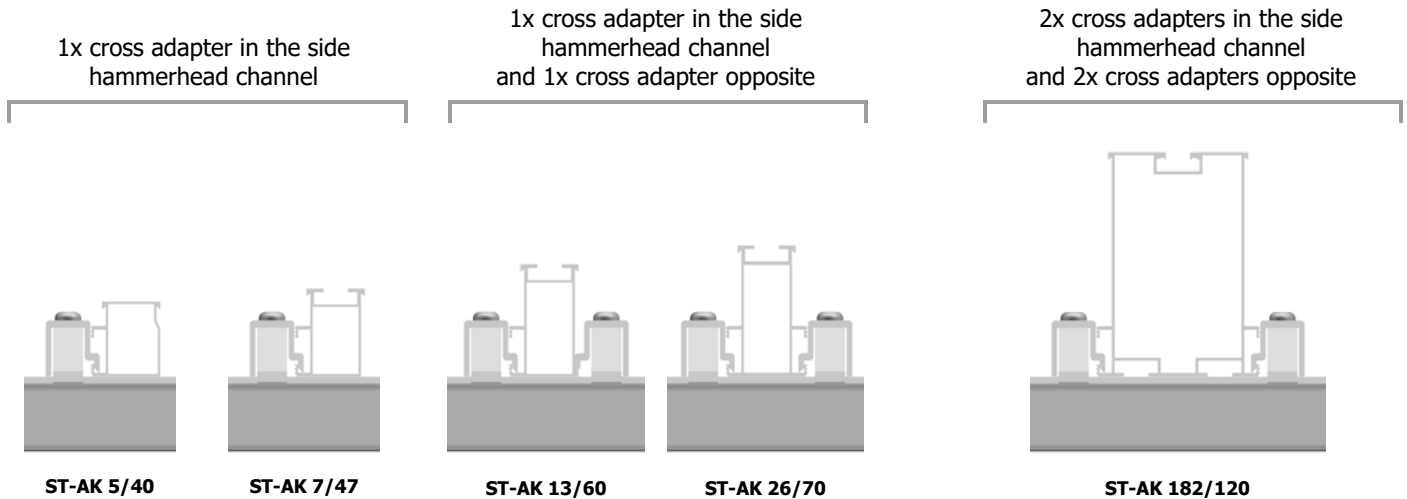

### 2.3 Frame assembly

#### 2.3.1 Mounting a vertical rail layer for transverse installation

The PV modules can be mounted in transverse orientation directly on the vertical rail layer. The precondition for this is appropriate spacing between the mounting rails. This can be freely chosen on purlin roofs and thus enables compliance with the clamping areas on the modules. Purlin roofs are the most commonly encountered roof type. The vertical mounting rails can also be selected as the bottom rail layer for a double-layer construction (upright module arrangement).

If the mounting rails are installed in a single layer or vertically as a lower layer (parallel to the verge), it must be ensured that the alignment of adjacent rails alternates, i.e. that the bracket connects alternately to the left or right of the rail. Always start with a complete mounting rail on the eaves side (bottom).

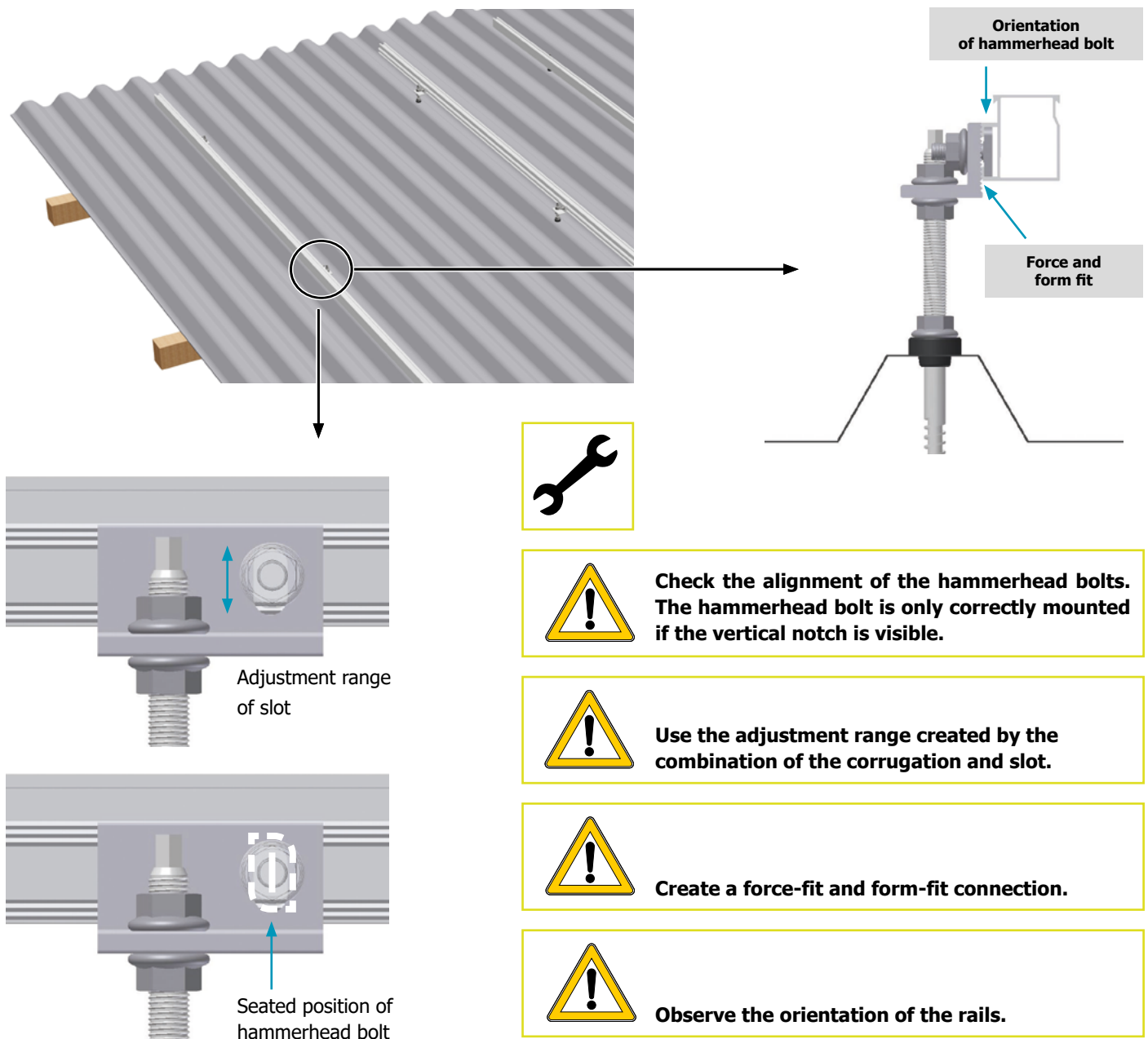

#### 2.3.2 Mounting a horizontal rail layer for upright installation

In individual cases, rafter/batten constructions or purlins with an ideal spacing (approx. 120–160 cm) may be encountered. The PV modules can be mounted in the upright orientation directly on the horizontal rail layer. The precondition for this is appropriate spacing between the mounting rails. On purlin roofs, this is defined by the purlin position; on rafter roofs, it can be freely chosen.

The horizontal mounting rails can also be selected as the lower rail layer for a double-layer construction (transverse module arrangement). If the mounting rails are installed in a single layer or horizontally as a bottom layer (parallel to the eaves), the mounting rail must be positioned with the hammerhead channel facing downwards. The bracket must always be fixed below the mounting rail on the eaves side.

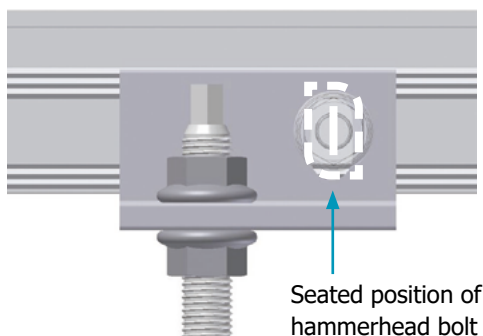
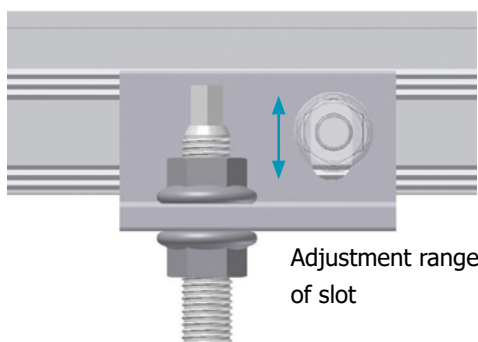
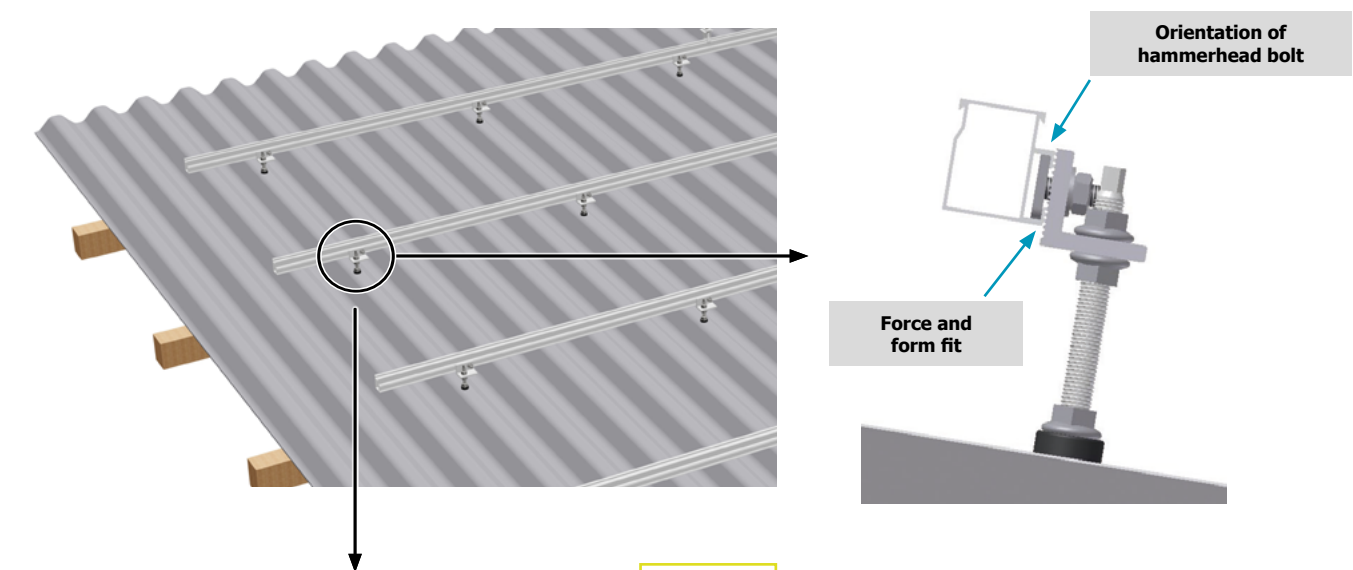

**Check the alignment of the hammerhead bolts. The hammerhead bolt is only correctly mounted if the vertical notch is visible.**



**Use the adjustment range created by the combination of the corrugation and slot.**



**Create a force-fit and form-fit connection.**





**Observe the orientation of the rails.**

#### 2.3.3 Installing the splice

To join several rails together, a splice with identical static values to the mounting rail is pushed half-way into the previously installed mounting rail. Then push the next mounting rail onto the splice. The connection is then complete. Fasten the pushed-on mounting rail as described above.

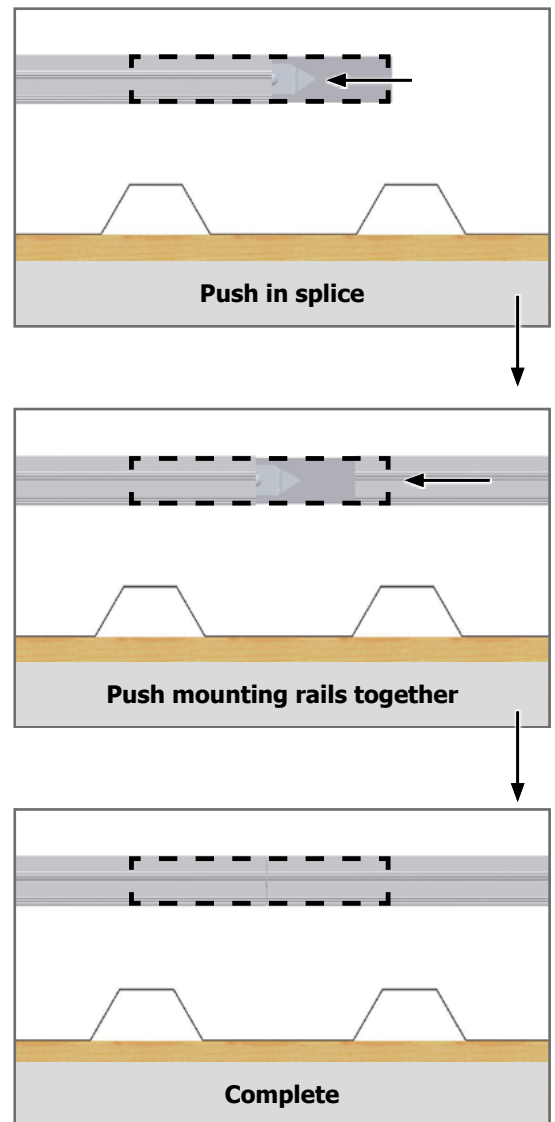
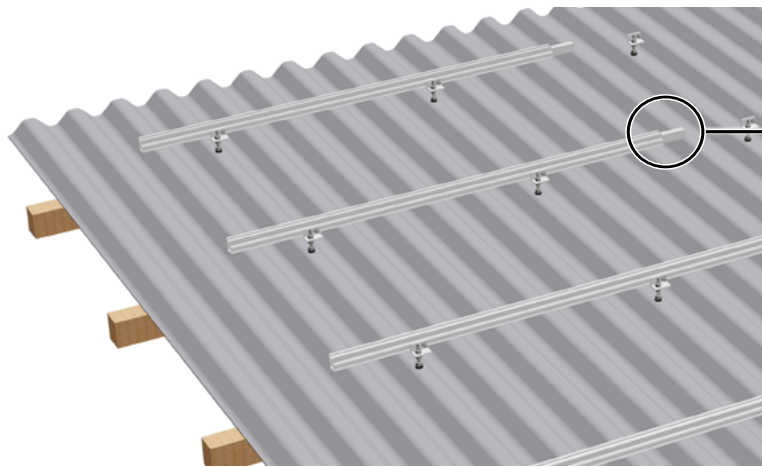
The mounting rails in the lower and upper rail layer can be connected in succession using splices, both for vertically and horizontally arranged mounting rails.



 **Push in splice.**

 **No cantilevers with splices. Position the splices so that they are between 2 brackets, 2 adapter rails or 2 mounting-rail intersection points.**

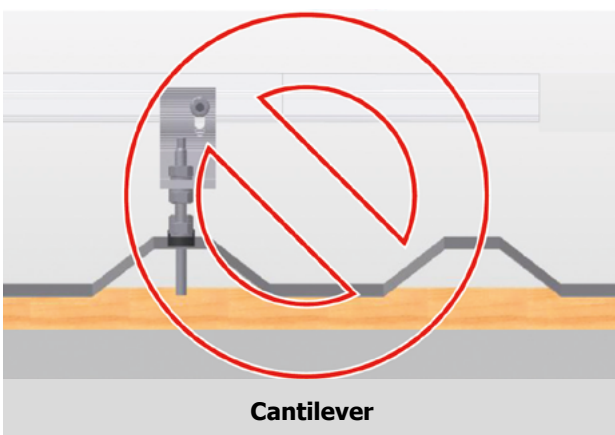

## 2 Hanger bolt/solar fastener installation

### Frame assembly with hanger bolts/solar fasteners

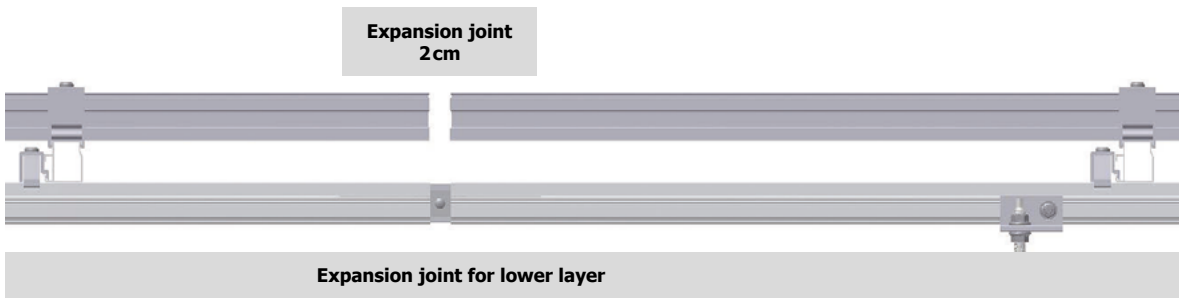

Expansion joint for the upper layer (for double-layer and single-layer substructures):



**If the mounting rail is longer than 12.00 m, the module array must be separated by placing two end clamps. With double-layer substructures, expansion joints are arranged in both layers. The rail must be separated in the area between the end clamps and connected with a splice to ensure a 2cm compensation in length (expansion joint). The arrangement of the expansion joints must be adapted in accordance with the structural conditions of the roof and the expansion properties of the respective materials. Modules must not be built over expansion joints.**

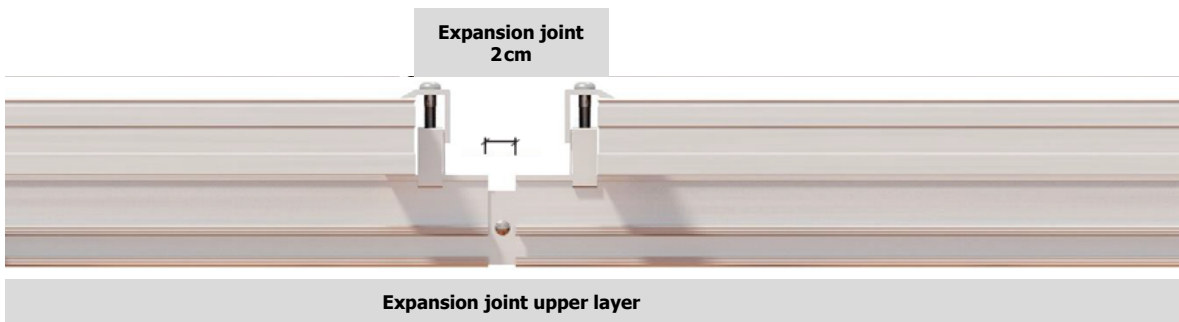

#### 2.3.4 Installing the cross connection

Load-bearing connection points between the lower and upper rail layers (in double-layer systems and when using adapter rails) can be quickly created using cross adapters.

Mount the upper mounting rails onto the bottom mounting rails using the cross adapters. To proceed, click a cross adapter onto the lower mounting rails and then use it to secure the upper mounting rail.

Ensure that the spacing between the upper mounting rails corresponds to the prescribed clamping distances for the module. Ensure that the cross adapter is clicked in on both sides of the mounting rail and fasten the screws tightly (torque 8–10 Nm).

Upper rail layer (horizontal):

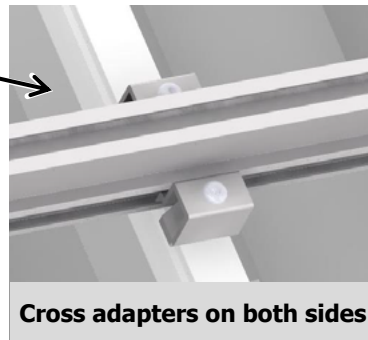
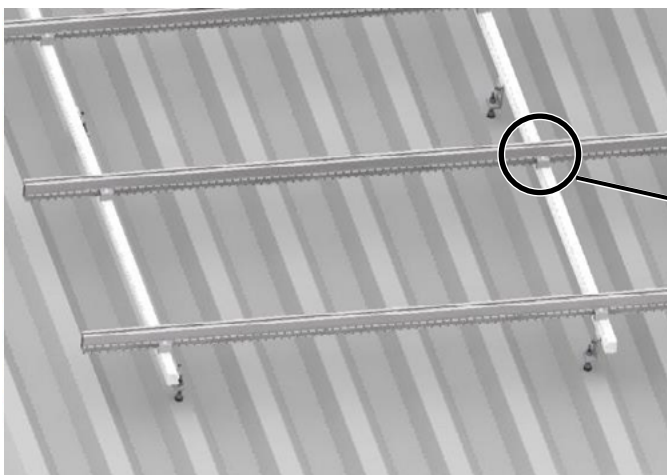

Upper rail layer (vertical):

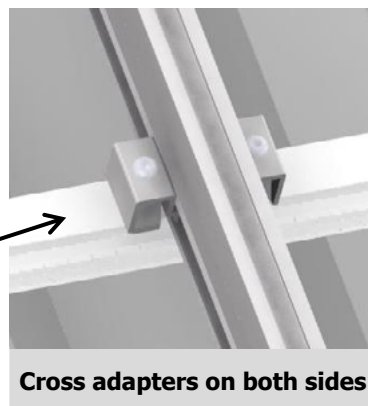
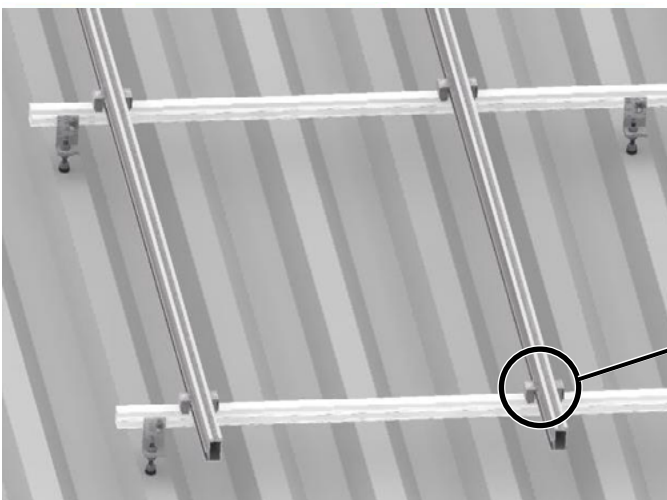

### Frame assembly with hanger bolts/solar fasteners

The number of cross adapters required per fixing point can be found in the project report. A second cross adapter is mounted as described above. Position it on the side of the rail opposite the first cross adapter (tightening torque 8–10 Nm).

#### Intersection points:

1x cross adapter in the side hammerhead channel

1x cross adapter in the side hammerhead channel and 1x cross adapter opposite



ST-AK 5/40

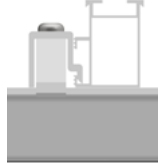

ST-AK 7/47

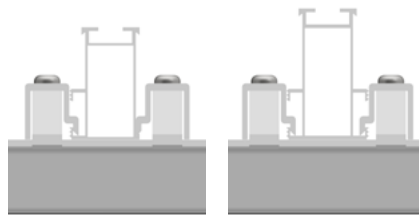

ST-AK 13/60

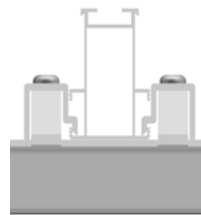

ST-AK 26/70

Specifications for the spacing between the vertical mounting rails can be found in the installation instructions.

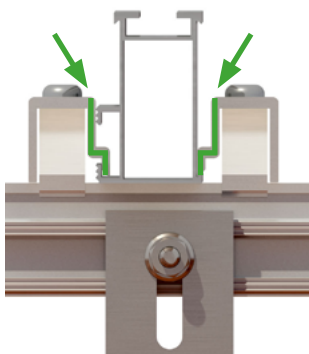

Cross adapter in the side hammerhead channel and on opposite side

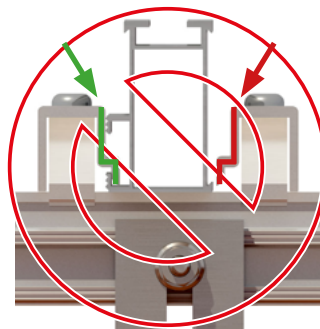

INCORRECT

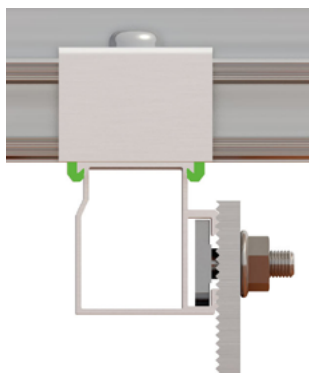

Both sides clicked in



INCORRECT

#### 2.4 Installing PV modules



**The installation instructions provided by the module manufacturer must be observed, especially with regard to clamping surfaces and clamping areas. S:FLEX GmbH is not liable for damage to the modules and all other consequences resulting from non-compliance with the module manufacturer's installation instructions.**



#### 2.4.1 Module installation, transverse

##### Module installation – (end clamps)

Place the module on the mounting rails. Install the end clamps. Click each end clamp on to the mounting rail and push it on to the module. Ensure that the end clamp is clicked in to both sides of the mounting rail.

Now adjust the end clamp to match the height of the module and tighten the screw (torque 8–10 Nm). Pay attention to the prescribed clamping areas and clamping surfaces. The distance between the module frame and rail end must be at least 35 mm.

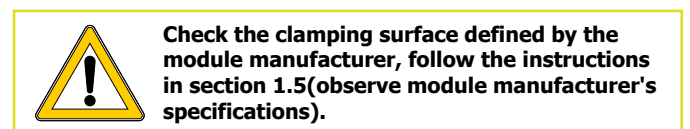
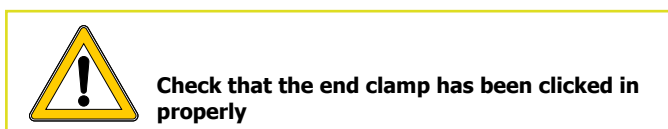
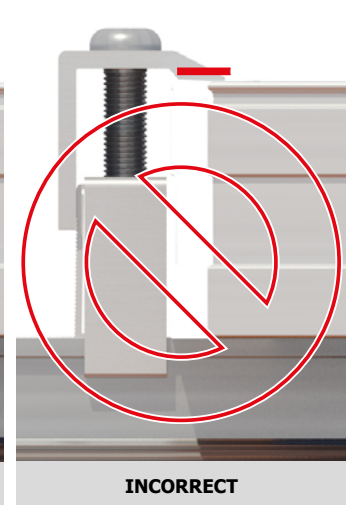
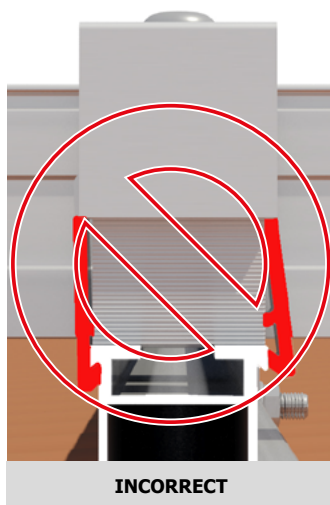
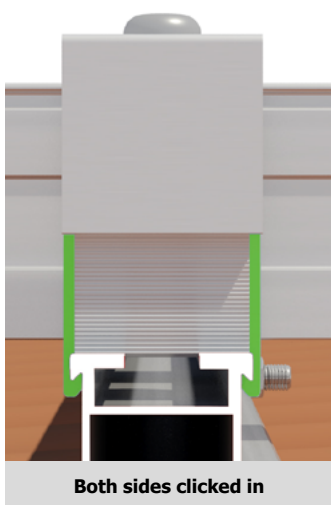
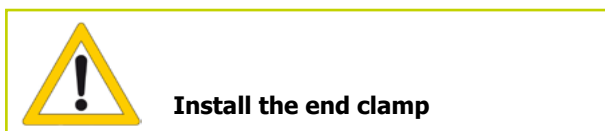
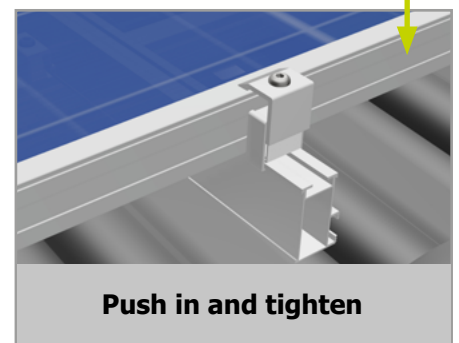
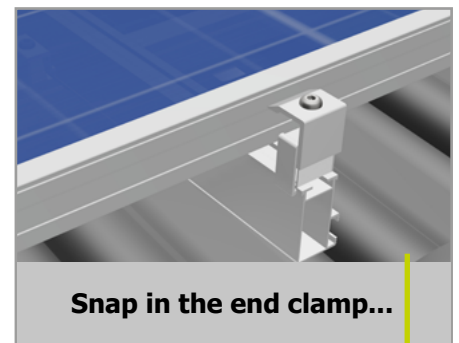
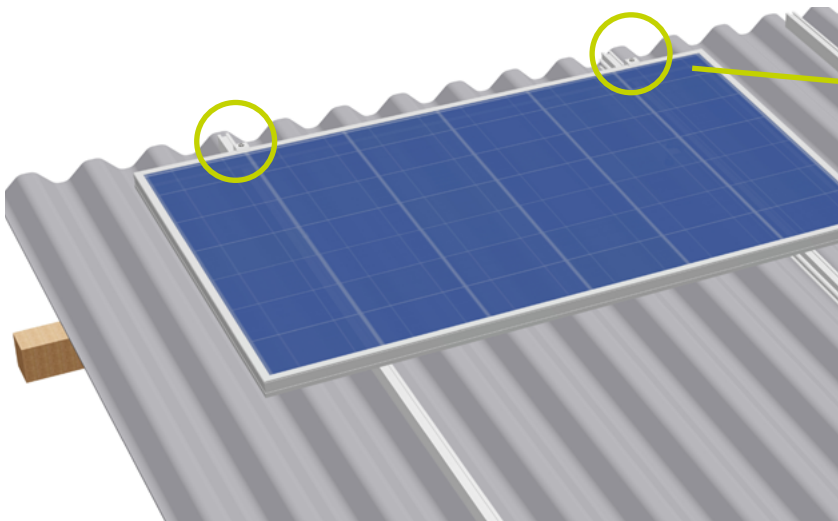

#### Module installation – (mid clamps)

Now install the mid clamps. The grounding plate must be fitted (if required) before mounting the mid clamp. The grounding plate is inserted laterally into the mid clamp between the "clamp" and the "upper part" (see 1.5). Next, click each mid clamp onto the mounting rail and push it on to the module. Ensure that the mid clamp is clicked in to both sides of the mounting rail.

Pay attention to the prescribed clamping areas and clamping surfaces. When using the grounding plate, the module must be positioned between the plate and the "upper part" of the mid clamp. The grounding plate is thus pressed against the mounting rail from the underside of the module frame.

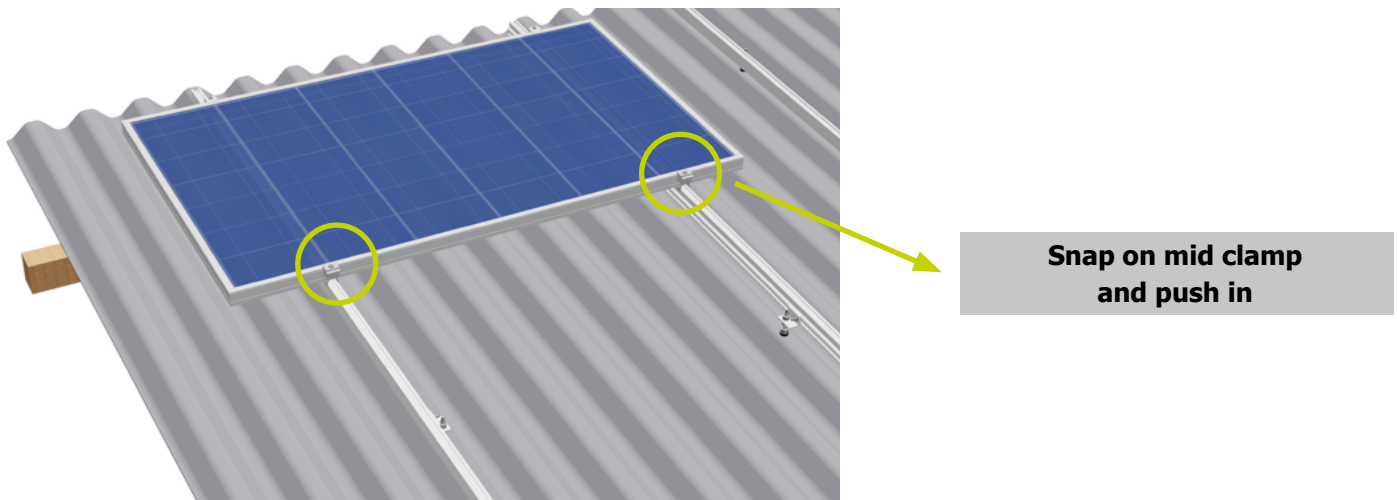

Now slide the next module underneath the mid clamp, adjust the mid clamp to the height of the module's frame and tighten the screw (tightening torque 8–10 Nm).

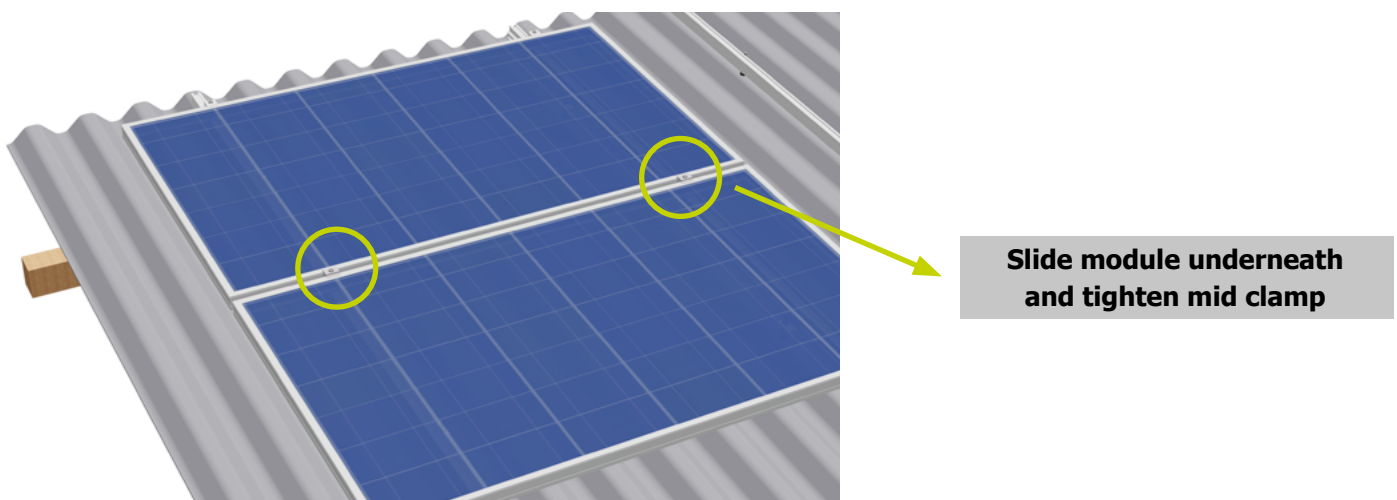

Ensure that the mid clamp grips both of the module frames on the clamping surface defined by the module manufacturer.

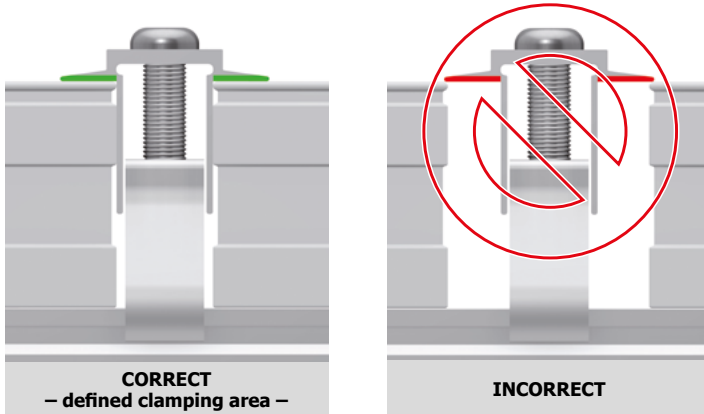

Mounting with grounding plate:

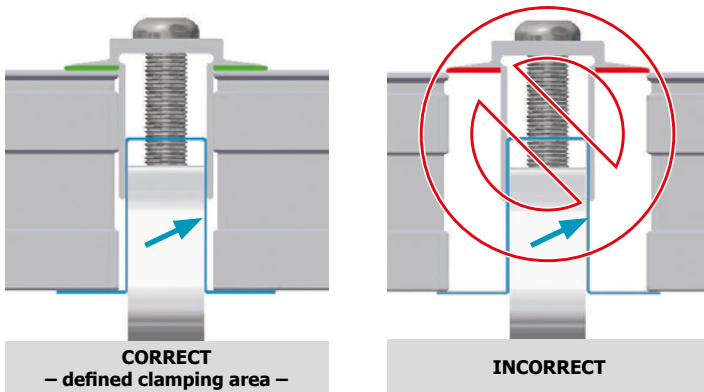

Check the clamping surface defined by the module manufacturer, follow the instructions in section 1.5 (observe the module manufacturer's specifications).

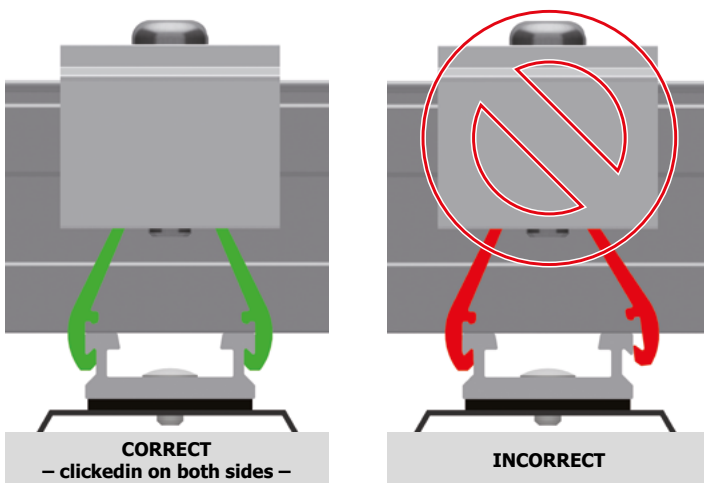

Check that the mid clamp has been clicked in properly.

#### Module installation – (end clamps at the end of the row)

End clamps must be fitted at the end of the module row and in the area of the expansion joints. Click each end clamp on to the mounting rail and push it on to the module. Ensure that the end clamp is clicked in to both sides of the mounting rail. Now adjust the end clamp to match the height of the module and tighten the screw (torque 8–10 Nm).

A locking clip must generally be mounted on the vertical rail below the bottom row of modules. The same applies to modules which do not have any modules directly below them (modules above obstructions such as windows, chimneys, etc.). The locking clip serves as additional slipping protection. Push the locking clip onto the mounting rails from below up to the end clamp and tighten it (tightening torque 8–10 Nm).

Pay attention to the prescribed clamping areas and clamping surfaces.

The distance between the module frame and rail end must be at least 60 mm.

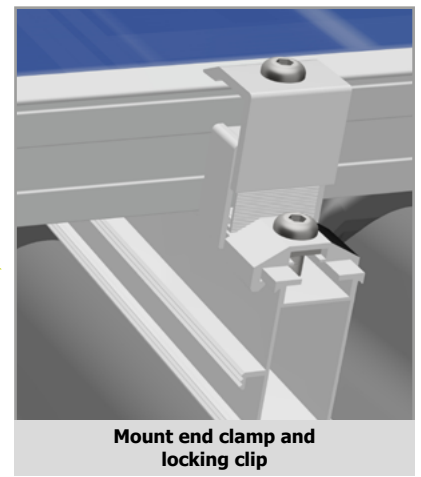
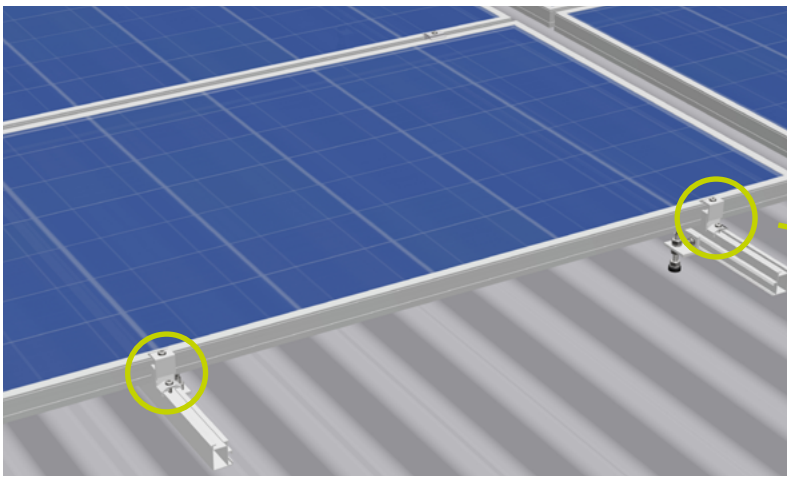

Proceed as described for the following rows.

It should be ensured here that all end clamps are secured in a horizontal line.

Align the upper row of modules with the aid of a guide or levelling instrument.



## 2.4.2 Module installation, upright

Before installing the modules in the lowest row of modules, the modules generally need to be equipped with slipping protection. The same applies to modules which do not have any modules directly below them (modules above obstructions such as windows, chimneys, etc.).



Fix two screws M6 x 20 (with the shank downward) with nuts M6 in two of the module's frame holes (8 mm) so that the screws are at the same level and, when installed, they are above at least one horizontal mounting rail layer.

If the lower mounting hole is larger than 8 mm, please use an appropriately sized (8 mm) screw.

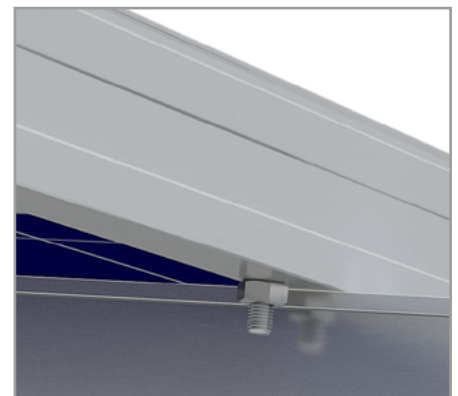
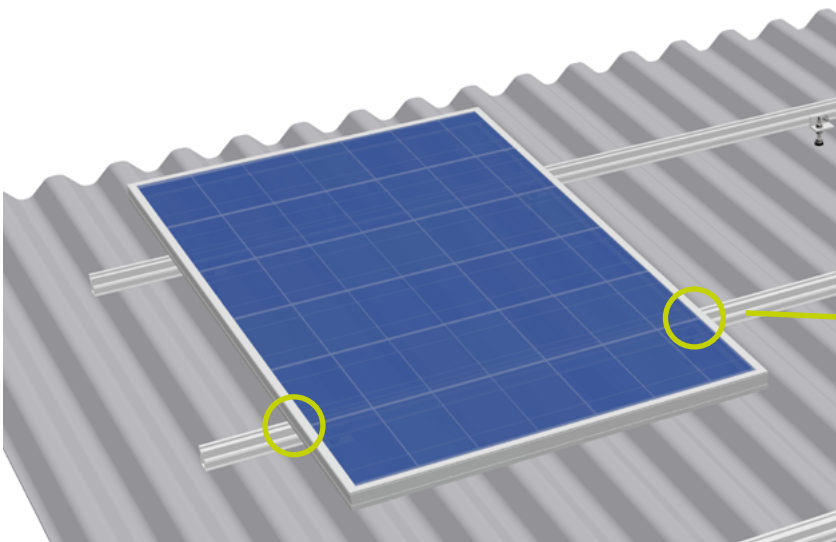

#### Module installation – (end clamps)

Place the module on the mounting rails. Install the end clamps. Click each end clamp on to the mounting rail and push it on to the module. Ensure that the end clamp is clicked in to both sides of the mounting rail. Now adjust the end clamp to match the height of the module and tighten the screw (torque 8–10 Nm). Pay attention to the prescribed clamping areas and clamping surfaces.

The distance between the module frame and rail end must be at least 35 mm.

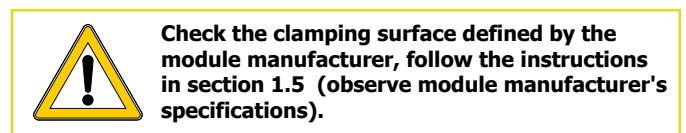
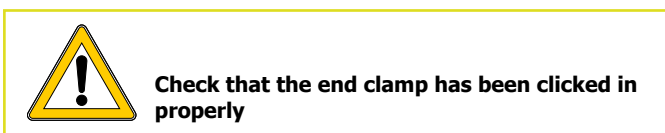
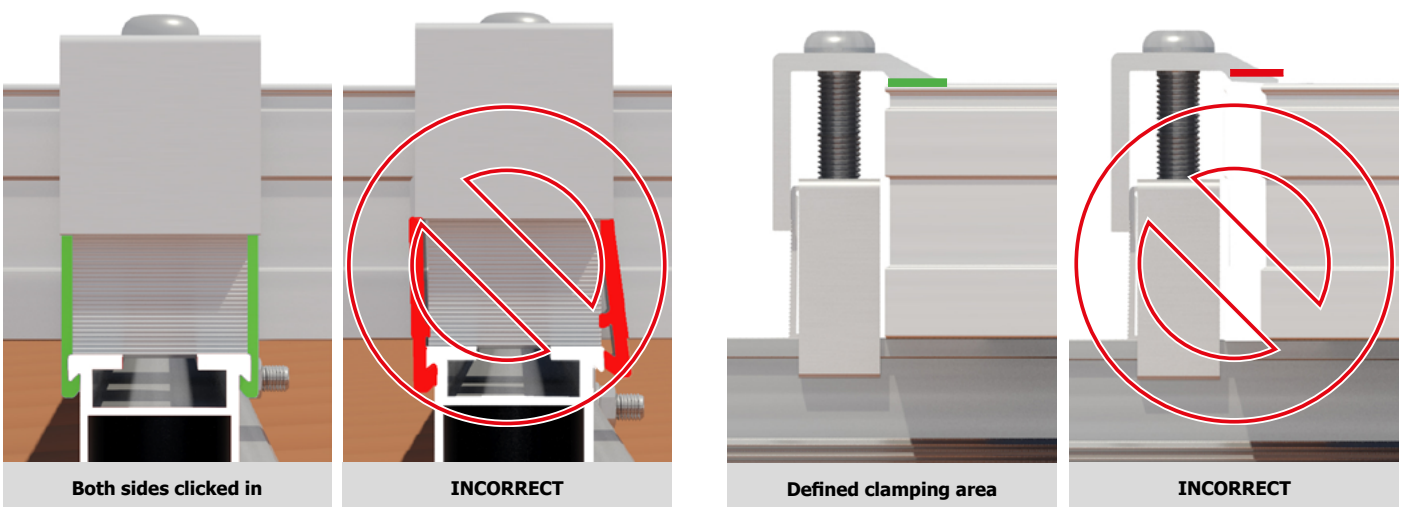
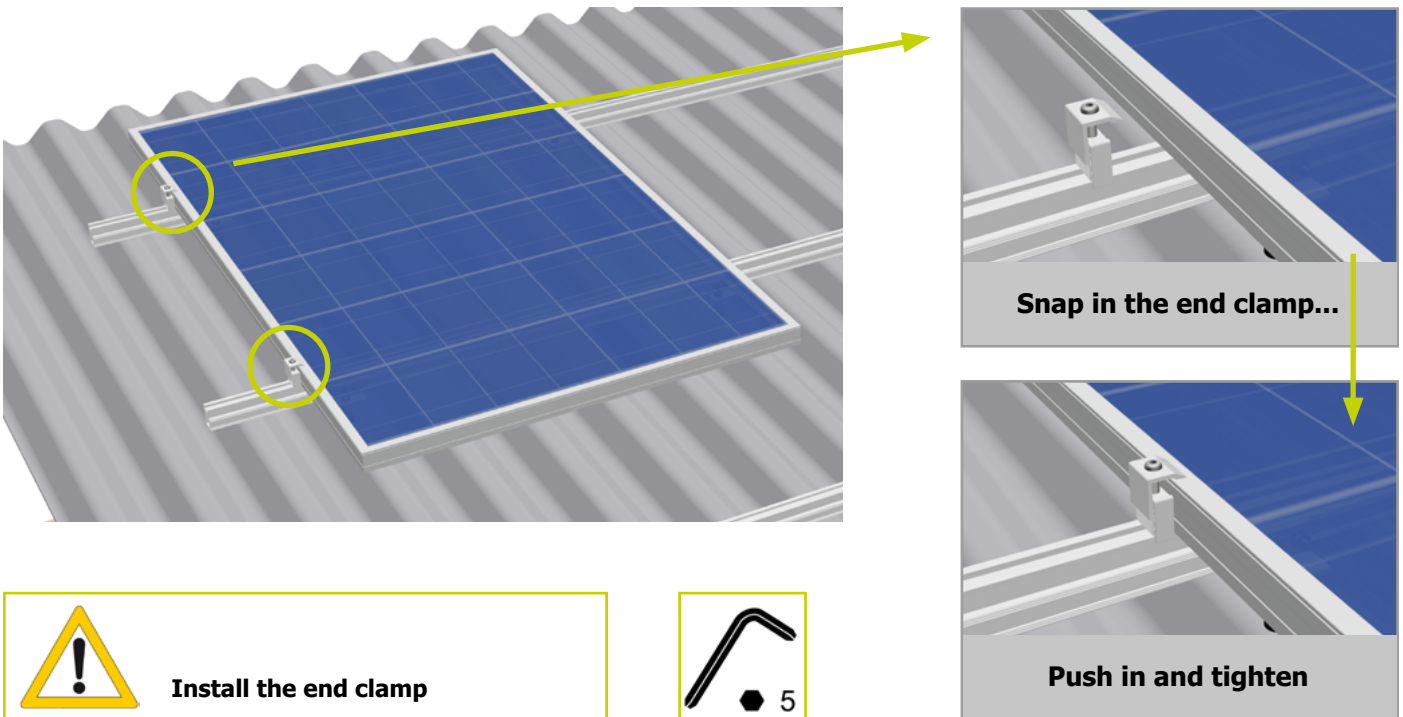

#### Module installation – (mid clamps)

Now install the mid clamps. The grounding plate must be fitted (if required) before mounting the mid clamp. The grounding plate is inserted laterally into the mid clamp between the "clamp" and the "upper part" (see 1.5). Next, click each mid clamp onto the mounting rail and push it on to the module. Ensure that the mid clamp is clicked in to both sides of the mounting rail.

Pay attention to the prescribed clamping areas and clamping surfaces. When using the grounding plate, the module must be positioned between the plate and the "upper part" of the mid clamp. The grounding plate is thus pressed against the mounting rail from the underside of the module frame.

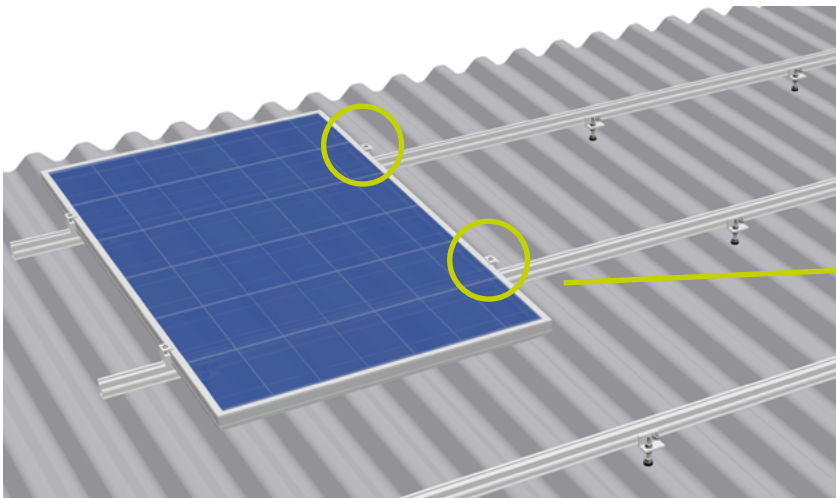

**Snap on mid clamp  
and push in**

Align the upper row of modules with the aid of a guide or levelling instrument.

Now slide the next module underneath the mid clamp, adjust the mid clamp to the height of the module's frame and tighten the screw (tightening torque 8–10 Nm).

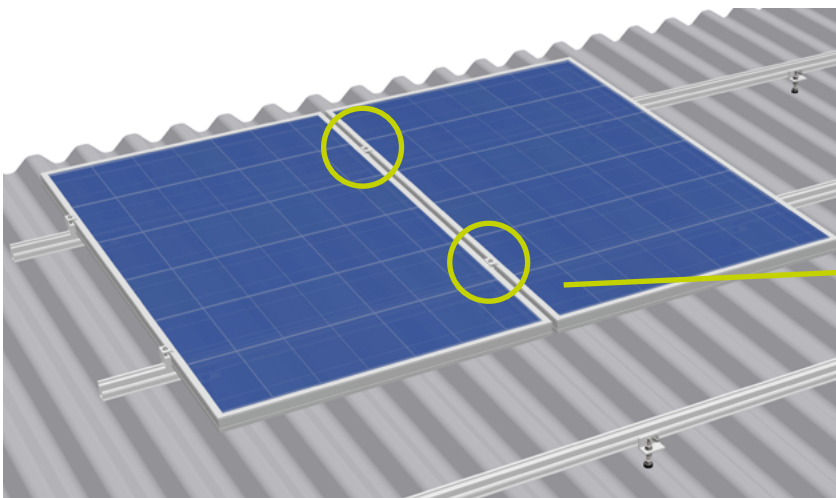

**Slide module underneath  
and tighten mid clamp**



Ensure that the mid clamp grips both of the module frames on the clamping surface defined by the module manufacturer.

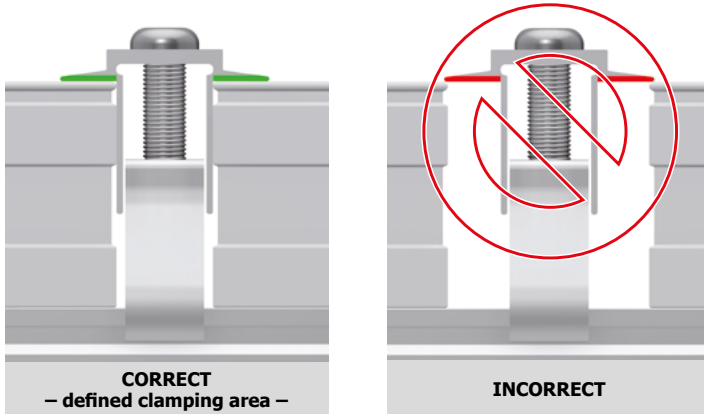

Mounting with grounding plate:

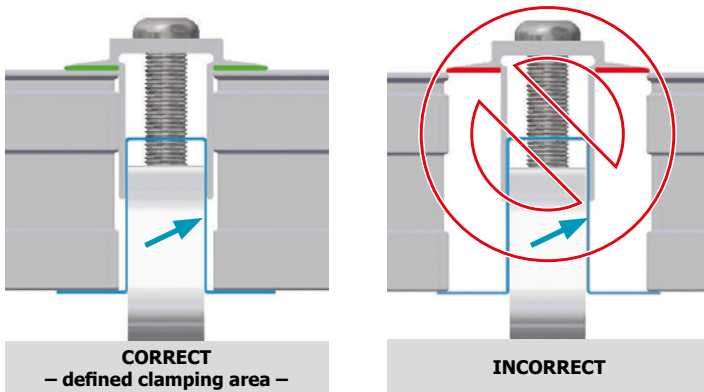

Check the clamping surface defined by the module manufacturer, follow the instructions in section 1.5 (observe the module manufacturer's specifications).

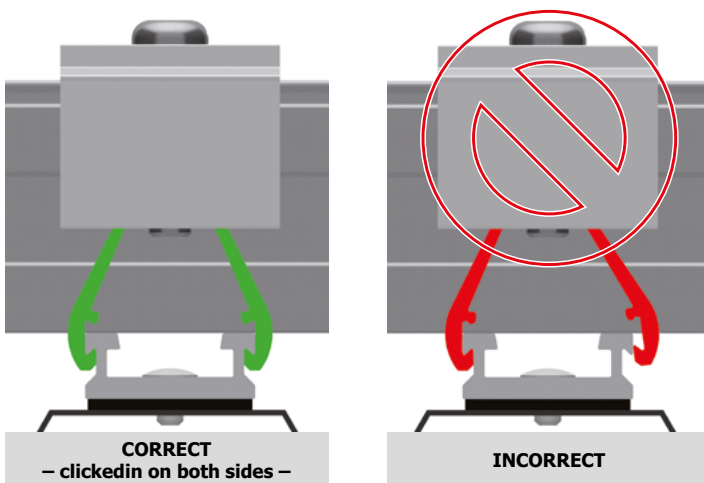

Check that the mid clamp has been clicked in properly.



#### Module installation – (end clamps at the end of the row)

End clamps must be installed on the last module in each row (if applicable, on expansion joints). Click each end clamp on to the mounting rail and push it on to the module. Ensure that the end clamp is clicked in to both sides of the mounting rail. Now adjust the end clamp to match the height of the module and tighten the screw (torque 8–10 Nm).

Pay attention to the prescribed clamping areas and clamping surfaces. Shorten projecting rails parallel to the module frame. The distance between the module frame and rail end must be at least 35 mm.

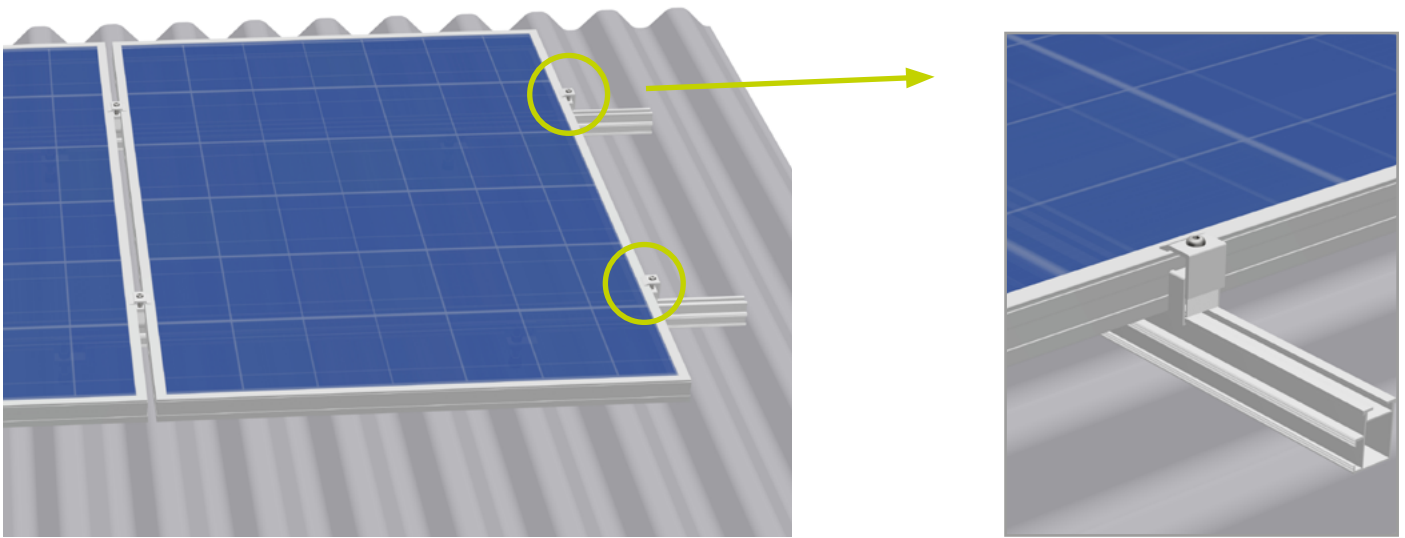

Proceed as described for the following rows.

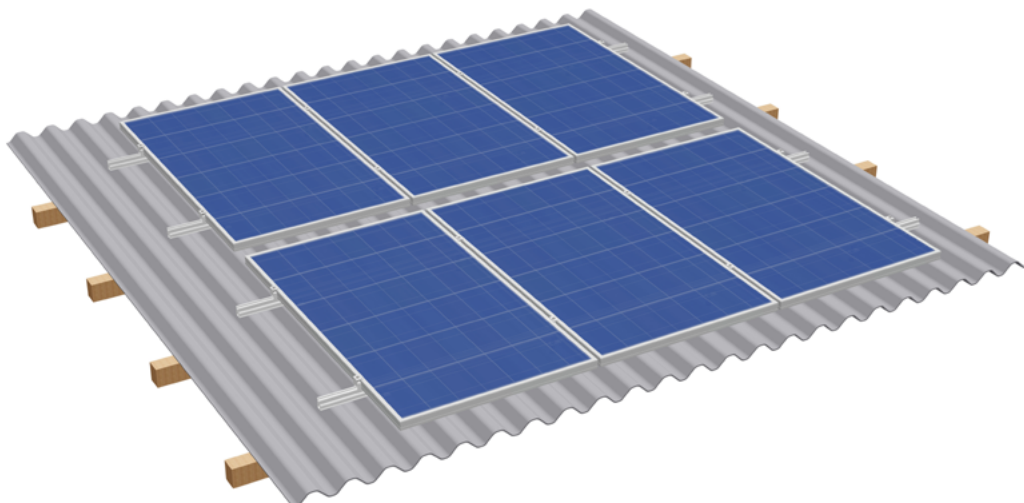

### 3.1 Disassembly

Disassembly of the S:FLEX mounting system may only be carried out by trained specialist personnel. Observe the same safety instructions, standards and guidelines as provided for the installation. In general, disassembly is carried out in reverse order to the described installation.



**Before disassembly, disconnect the PV modules from the mains network. Disconnect all of the PV modules' electrical cables (string lines and plug connectors) and remove them from the frame system.**



**Then remove the modules and store them safely. Improper disassembly can lead to damage to the modules.**



**Disassemble frame system and safely store all of the parts. Any holes in the roof must be sealed by a specialist.**

### 3.2 Disposal

The S:FLEX mounting system is made from aluminium, stainless steel and steel components. These materials can be recycled after disassembly. The frame system must only be disposed of by a specialist waste management company. Observe the applicable national standards and guidelines.

### 4.1 User agreement for hanger bolts/solar fasteners

We expressly point out that the assembly system is sold under a purchase agreement.

Its installation/processing or acquisition by a third party is not carried out in the name of, or on behalf of, S:FLEX GmbH. Installation/processing of the system must be carried out by appropriately qualified personnel and strictly in accordance with the installation instructions.

The design and planning of the system must be carried out using the S:FLEX planning software. S:FLEX GmbH is neither responsible for the project-specific structural analysis of the roof structure, nor for obtaining and documenting the approval of the roof manufacturer for use of the respective fastening systems on the roof in question (in the terms of the warranty), nor for correct installation of the fastening system.

S:FLEX GmbH accepts no liability for faults and damage and/or a restricted or limited operational capability of the system which has resulted from incorrect installation and/or installation which was not carried out in accordance with the installation instructions and/or the project report. In the case of incorrect installation, the buyer's right to assert claims for material defects shall expire.

The system warranty is only valid if all system components were acquired from S:FLEX GmbH.

### 4.2 Warranty / disclaimer

The information regarding dimensioning provided in these instructions is merely suggested values based on prior experience. Binding structural analyses for installation frames can be created using the S:FLEX planning software.

As an installation company, you are responsible for the correct execution of the installation. S:FLEX GmbH is not liable for the dimensional information contained in commercial system quotations.

As the installation company, you are responsible for the mechanical durability of the installed interface connections on the building envelope, in particular also for their watertightness. The components supplied by the company S:FLEX GmbH are designed for the expected loads and in accordance with the currently available technology.

In this context, you must provide the company S:FLEX GmbH with information about all general technical conditions in writing via the project data collection sheet (information about the supporting structure, snow load zone, building heights, wind loads, etc.).

S:FLEX GmbH is not liable if the installed components are not properly handled. Any use close to the sea needs to be clarified with S:FLEX GmbH directly on a case-by-case basis due to the increased risk of corrosion. Provided that the system is handled properly and dimensioned according to the structural conditions and normal environmental and ambient conditions, the company S:FLEX GmbH provides a warranty from transfer of risk to the warranty holder, which guarantees that the metallic components of the racks will remain free from defects with regard to material and workmanship for a period of 10 years. This warranty does not apply to wear parts. For additional information, please refer to the separate warranty provisions.

This applies within the context of the generally prevalent weather and environmental conditions.